

Narrow-aisle warehouses.

Intralogistics system solutions
from a single source.

Contents

STORAGE TECHNOLOGY WITHIN INTRALOGISTICS	04
MATERIAL FLOW CONSULTING	06
FLOORING	08
Structure and requirements	10
Additional measures for uneven travel surfaces	12
RACKING	14
Pallet racking	16
Mobile pallet racking	20
High bay shelving	23
Shuttle compact storage	26
Layout	28
Requirements for installation	32
Warehouse organisation	36
GUIDANCE SYSTEMS	40
Mechanical guidance	42
Wire guidance	46
SAFETY AND ASSISTANCE SYSTEMS	52
Differences between safety and assistance systems	54
Assistance systems	55
Safety systems	60
PPS personal protection system	62

PROCESS OPTIMISATION	64
Mobile IT & scanning solutions	66
Logistics Interface	68
RFID technology	69
warehouseNAVIGATION	71
Jungheinrich WMS	74
TRUCKS IN THE NARROW-AISLE WAREHOUSE	76
EFX 411 / 414: All-rounders with a front seat	79
EKX 410–516: The top performers in the segment	80
EKX 514a / 516ka / 516a: Mobile robots	83
EKS 3s and EKS 4s: The performance enhancers in narrow aisles	84
ENERGY SUPPLY	86
Energy solutions at a glance	88
Li-ion technology	91
Energy efficiency	92
SPECIAL SOLUTIONS	94
EKX special cold store equipment	96
JUNGHEINRICH FACTS	98

Storage technology within intralogistics.

A comparison of systems.

As one of the world's leading intralogistics providers, we have the perfect solution for every requirement. Not only do we supply all components and integrate the solution into your system environment, we also offer comprehensive advice and reliable after-sales services to ensure your warehouse is optimally equipped for many years to come. Find out how you can exploit the full potential of your narrow-aisle warehouse now and in the future.

CHARACTERISTICS

A narrow-aisle warehouse makes optimal use of the available space in all directions. The small footprint of the working aisles combined with greater lift heights results in an optimal use of space.

OBJECTIVE

With ever-increasing demands on speed and throughput, a narrow-aisle warehouse provides excellent opportunities to get more out of your existing storage space. As a system provider, Jungheinrich perfectly coordinates all components, including flooring, trucks, guidance systems and racking, and ensures highly efficient operation of the system, whether this is manual, semi-automated or fully automated.

PLANNING

During the planning and implementation stages, particular attention must be given to the small safety margins, high levels of performance and lift capacities of the trucks. This is the only way to ensure the safety of people, goods, trucks and warehouse equipment at all times. The success of the project depends on interface coordination and interaction. We will be on hand to offer tailored advice at every stage and will adapt the entire process as often as necessary to meet your requirements.



WIDE-AISLE WAREHOUSES

NARROW-AISLE WAREHOUSES

HIGH-BAY WAREHOUSES

	WIDE-AISLE WAREHOUSES	NARROW-AISLE WAREHOUSES	HIGH-BAY WAREHOUSES
Type of storage	Floor and racking	Racking	Racking
Types of racking	Channel, single-bay or multi-bay systems	Single-bay or multi-bay systems	Channel, single-bay or multi-bay systems, silo
Operation	Manual	Manual, semi-automated and automated	Automated, rarely manual
Storage and removal trucks	Tiller trucks, front stackers and reach trucks	Tri-lateral stackers	Stacker cranes
Order-picking trucks	Low-level and medium/high-level order pickers	Tri-lateral stackers or medium/high-level order pickers	Stacker cranes
Aisle width	2,500–4,500 mm	1,400–1,800 mm	1,400 mm
Lift height	Up to approx. 12,000 mm	Up to approx. 18,000 mm	Up to approx. 35,000 mm
Utilisation of space	Low to high	Medium to high	High
Throughput	Medium to high	Medium to high	Medium to high
Investment costs	Low to medium	Medium	Very high

Material flow consulting.

Plan your resources with us.

Your narrow-aisle warehouse should be primed for maximum efficiency in the smallest of spaces. This is the only way to achieve your productivity goals in a challenging environment. And, of course, this environment changes over time. Demands grow, product ranges evolve, standards and intralogistics processes have to move with the times.

By speaking to one of our professional material flow consultants, you can set clear objectives, optimally plan your narrow-aisle warehouse right from the start and identify potential for improvement. Together, we can ensure your business has a bright future ahead!

WHATEVER YOUR OBJECTIVES, WE WILL HELP YOU TO REACH THEM.



Reduction in operating costs

You want to identify savings potential in the company. In this situation, we will closely examine your warehouse processes and consider how you can achieve your economic targets with a perfectly planned narrow-aisle warehouse.



Expansion of capacities

Your business is evolving, and the demands for efficiency, productivity, throughput and flexibility are increasing accordingly. In order to meet the expectations of your customers effortlessly in the future, you need a plan. However, there is one parameter that is set in stone: your storage space. This is where narrow-aisle solutions can help you to achieve the desired effect.



Higher degree of automation

Perhaps you want to minimise potential errors, make the best use of your personnel, become more flexible: there are many advantages to partial or full automation. We can suggest a number of technically and economically viable options for your narrow-aisle warehouse.



Greater energy efficiency

Energy-efficient warehouse processes support your sustainable corporate strategy. When capacities are better managed and innovative technologies are used, consumption can be reduced and profitability increased.

HOW DOES THE MATERIAL FLOW CONSULTATION SERVICE WORK?

We offer several options, from an initial overview to a detailed concept or a combination of services:



▶ Rapid expert assessment of optimisation potential

▶ Outline of possible solutions

▶ Analysis of the current material flows and process requirements

▶ Definition of the target performance and capacity requirements

▶ Decisions based on viable economical and technical solutions

▶ Holistic approach: IT (WMS), process, technology, TCO (Total Cost of Ownership)

Flooring.

The foundation of your success.

The function and performance of a narrow-aisle warehouse are significantly influenced by the quality of the floor. Only on level ground can narrow-aisle trucks perform to full capacity, travel quickly and transport the goods safely through the narrow aisles. The VDMA guidelines specify the minimum requirements for the base layer and floor slab. But why stop there? At Jungheinrich, we are already thinking one step ahead with our patented technology. The Floor Pro vibration damping system, now used in EKX series trucks, compensates for unevenness such as waves or dents. You can therefore achieve optimum performance, even on the types of suboptimal floor commonly found in warehouse environments.



Structure and requirements.

STRUCTURE

As a rule, an industrial floor consists of a base layer, concrete layer and top layer (screed). The layers below the concrete layer are used, for example, to compact the subsoil, protect against moisture or provide thermal insulation.

REQUIREMENTS

With regard to strength, the top layer (screed) must meet the requirements of stress group II as set out in DIN 18560, Part 7, Table 1. The floor may not exhibit any plastic deformation under load. Shafts, ducts or other breaches in the surface must be located at least 200 mm from the travel lanes. Such elements should be avoided altogether in the working aisle.

- ▶ The floor must be resistant to oils and greases.
- ▶ The surface of the travel lane must be wear-resistant and must not produce excessive dust.

The ground leakage resistance must not exceed 10^6 ohms in accordance with IEC 1340-4-1, DIN EN 1081. The grip of the floor must comply with ISO 6292 (empirical value: approx. 0.5μ).

STANDARDISATION

The basic requirements are derived from national standards. The load-bearing substrate must comply with the applicable standards (for example, DIN 1045 and DIN 18202).

Taking into account possible subsidence, the load-bearing substrate must be prepared in such a way that the angular tolerances of the finished floor do not exceed 15 mm.

Tolerances in accordance with DIN 18202 (see Table 1) apply to all areas of the warehouse floor. In the narrow-aisle area and aisles, the tolerances specified in the VDMA guidelines and FEM 4.103-1 / FEM 10.2.14-1 apply.

FLOOR QUALITY

Nowadays, high-bay warehouses operated with narrow-aisle trucks are so technologically advanced that they allow users to achieve high throughput rates with impressive volume utilisation. As a result, not only are the industrial trucks subject to high technical demands, but the structures surrounding the truck, in particular the floor, also have to satisfy certain minimum requirements. In order to transport the truck as smoothly and safely as possible, the requirements of the VDMA guidelines on floor requirements for narrow-aisle trucks must be observed. Maximum truck performance relies on optimal ground conditions.

In terms of content, the VDMA guidelines and FEM 4.103-1 / FEM 10.2.14-1 focus on three areas:

- ▶ Changes to demands on surface smoothness
- ▶ Waviness evaluation
- ▶ Definition of a measurement procedure for waviness

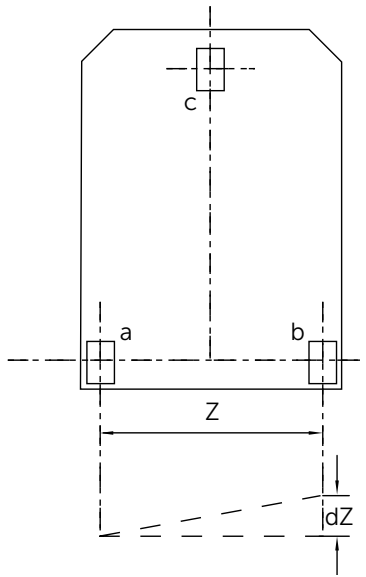

Height differences across the travel direction based on the VDMA guidelines

The guidelines are available to download from the VDMA website. A sample calculation can be found in Appendix B1.

Uppermost racking beam (m)	Z _{SLOPE} (mm/m)	dZ = Z x Z _{SLOPE}
15	1.0	Z x 1.0 mm/m
10	1.5	Z x 1.5 mm/m
up to 6	2.0	Z x 2.0 mm/m

Note: Interpolation is required for rack heights >6 m.

Z is the dimension between the centre of the truck load wheels (a, b) in m and Z_{SLOPE} is the permissible incline perpendicular to the aisle between the centre of the truck load wheels (a, b) in mm/m. The parameter dZ is the difference in height between the centres of the truck load wheels (a, b). dZ is specified as shown.

CHANGES TO DEMANDS ON SURFACE SMOOTHNESS

The VDMA guidelines and FEM 4.103-1 / FEM 10.2.14-1 specify requirements for both the lengthwise and crosswise surface smoothness of the traffic lane. The basic principle for measuring these criteria is derived from the two current standards and has been widely implemented in practice.

WAVINESS EVALUATION

This formula for the floor requirement is based on a key figure (F_x), which is calculated using statistical methods (keyword: standard deviation) from a series of height differences of adjacent measuring points. Smaller F_x values represent increased waviness with larger amplitudes and thus reduced levelness of the floor. The guidelines describe the process for calculating the key figure in great detail, and the VDMA also has a spreadsheet that automatically calculates the key figure based on the raw data.

DEFINITION OF A MEASUREMENT PROCEDURE FOR WAVINESS

The VDMA guidelines also give a clear definition of the measurement procedure and includes a helpful schematic drawing of the measuring device. This ensures that the measurement results are reproducible and comparable. The requirements for the waviness of the floor are set out in the VDMA guidelines (paragraph 4.2.3). The guidelines and the calculation tool mentioned are available on the VDMA website.

Table 1:
Finished floor outside the narrow-aisle area (loading zone)

Spacing of the measuring points up to	0.1 m	1 m	4 m	10 m	from 15 m
Max. permissible variation from levelness (pitch)	2 mm	4 mm	10 mm	12 mm	15 mm

The levelness is tested in accordance with DIN 18202.

Table 2:
Levelness tolerances along the travel direction for all heights, based on the VDMA guidelines

Spacing of the measuring points	1.0 m	2.0 m	3.0 m	4.0 m
Max. permissible variation from levelness, pitch as limit value in the traffic lanes	2.0 mm	3.0 mm	4.0 mm	5.0 mm

The levelness is tested in accordance with DIN 18202.

The requirements for the waviness of the floor are set out in the VDMA guidelines / FEM 4.103-1 / FEM 10.2.14-1 (paragraph 4.2.3).

ELECTROSTATIC CHARGE IN WIRE-GUIDANCE AND RAIL-GUIDANCE SYSTEMS

The dissipation properties of the floor with regard to electrostatic charges are also of particular importance. The level of discharge resistance depends on the local conditions and the individual materials used, but should be < 10⁶ ohms. The use of insulating plastics for floor construction and coating must be avoided. An insulating coating prevents the static charge from being discharged into the ground and can lead to the malfunction or failure of the truck.

Additional measures for uneven travel surfaces.

FLOOR PRO: MAXIMUM PROTECTION FOR PEOPLE AND GOODS

Jungheinrich Floor Pro vibration damping reliably reduces the vibrations of your truck. This minimises the risk of damage to your goods on longer routes and uneven floors and at high lift heights. Smoother travel combined with higher speeds results in a significant increase in throughput.

The benefits for you:

- ▶ Effective compensation of uneven floors
- ▶ Up to 33% increase in travel speed in narrow aisles
- ▶ Increase in throughput

sideshiftPLUS

With sideshiftPLUS, Jungheinrich increases the reach distance by an additional 100 mm on both sides. This reduces the need to leave large safety margins in narrow aisles. A sub-optimal travel surface often leads to poor positioning of the goods during storage and removal. Thanks to sideshiftPLUS, however, larger distances can now be covered more effectively. A smaller driver's cabin can also be selected, further increasing the safety clearance to the rack. As a result, the required distance is maintained between the goods / truck and the rack at all times, even with poor quality flooring.

INDIVIDUAL TRAVEL PROFILES

Transponder technology can be used to adjust the travel speed automatically as soon as the truck passes over uneven ground. Organisations are therefore able to strike the perfect balance between flooring investment and truck performance. The slight reduction in speed rarely has a significant impact on throughput. For a large number of businesses, Jungheinrich transponder technology offers an efficient method of protecting operators, goods and trucks.

Better performance on uneven surfaces.

Thanks to the patented Floor Pro vibration damping system.

Don't let anything slow you down when it comes to increasing throughput in your warehouse – not even the quality of your floor. You can now work faster and more efficiently, even on uneven and bumpy floors, thanks to Jungheinrich's internationally unparalleled vibration damping system for improved performance in narrow aisles. The EKX is the first high-rack stacker on the market with a vibration absorber, freeing you from the limitations of your flooring.

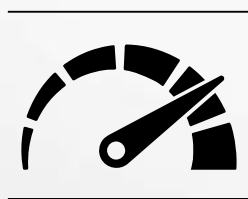

Up to
33%
faster
driving
on uneven
surfaces.

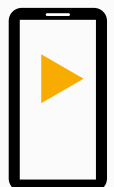

See the Floor Pro in use at Samdistribution.

Racking.

A pillar of strength in your narrow-aisle warehouse.

Racking is available in a variety of designs. Jungheinrich has the appropriate, quality-tested solution for every application and every load – and can combine this with compatible trucks.

The loading devices, weights and dimensions of the loads, as well as the types of trucks, are all critical factors in choosing suitable racking. Pallet racking is particularly popular due to its versatility, but Jungheinrich offers a much wider range of products to maximise available space in a narrow-aisle warehouse.

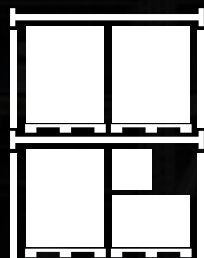
**PALLET RACKING**

The all-rounder of the narrow-aisle warehouse

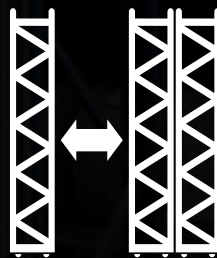
**MOBILE PALLET RACKING**

Saves on aisles, saves on space

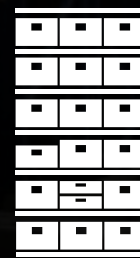
**HIGH BAY SHELVING**

Ideal for small parts and picked goods

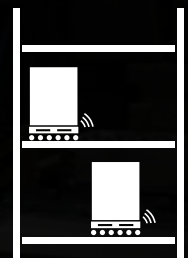
**SHUTTLE COMPACT STORAGE**

Smart system for high throughput

Pallet racking.

The versatile solution that grows with you.

Pallet racking in narrow aisles is ideally suited to storing large quantities of individual, primarily palleted items. These systems show their strength in situations where high throughput is required in a small space. They offer all the advantages of multi-bay racking, such as direct access and flexible arrangement of beams, but require less space and enable extreme lift heights. The optional double-depth storage enables even more efficient use of space. Rail or wire guidance and semi-automated or fully automated narrow-aisle trucks are used for operation.

Pallet racking is primarily used in combination with narrow-aisle systems. Depending on the weight of the load, it can be set up as a single-bay or multi-bay system.

As a structure that is completely separate from the building, free-standing pallet racking offers great versatility. Users also have the option to modify the racking at a later date if the operating conditions change.

Advantages at a glance:

- ▶ Narrower aisle widths for greater utilisation of space
- ▶ Direct access to all items
- ▶ Flexible beam arrangement for high level of adaptability
- ▶ Easy to set up with few components
- ▶ Order picking even at great heights

Structural tests are carried out in accordance with EN 15512 "Steel static storage systems – Adjustable pallet racking systems – Principles for structural design". Jungheinrich pallet racking is also based on the following European standards: EN 15620, EN 15629, EN 15635.



Pallet racking in narrow aisles with cantilever transfer station.

Order picking in narrow aisles.



Automated.
Whether you need a conventional or automated system, with or without order picking, Jungheinrich pallet racking always adapts to your requirements.



Jungheinrich pallet racking for narrow aisles opens up a wide range of opportunities.

The racking uprights consist of two C-shaped upright profiles with stiffening beads, which are bolted to a truss to form a rigid frame construction. The angle connectors of the racking beams, which fit into the system bore holes of the racking uprights, are welded on on both sides. The design of the connecting pieces ensures excellent connection rigidity due to their form-fit connection and slanted hole design in the upright.



Pallet racking.

Structure and elements.

Pallet racking in a narrow-aisle warehouse uses virtually the same components as racking in a standard wide-aisle warehouse. Racking uprights and suspended racking beams form a stable framework for almost all applications.

The type of profile and shape of profile for the load-bearing elements of the pallet racking are determined by the specific load case. By spacing the holes in the racking upright profiles at 50 mm, the structure can be flexibly adapted to individual requirements.

The Jungheinrich pallet racking system, which saw a number of new additions to the standard product range in 2021, is now capable of transporting heavier loads as well as transporting loads in areas with extreme acceleration levels (earthquake zones).



Pallet racking system with specialist equipment (galvanised mesh).



Pallet racking system with specially configured racking uprights (X configuration). Used for transporting heavy loads in earthquake zones.

Mobile pallet racking.

The flexible aisle system for small spaces.

Aisles between rack units drive up your space requirements. Mobile rack units are an effective solution and can achieve space savings of up to 90%. With this system, a working aisle is opened by pushing apart the racks only where you need to gain access. The technology behind this is Jungheinrich pallet racks that are mounted on electrically driven bases ("carriages"). The units are either controlled centrally from the individual rack or via remote control. The space saved is of course available as additional storage space. This results in an extremely high utilisation of space, which is even more advantageous in a narrow-aisle warehouse. Simple operation ensures quick access to any item at all times.

Advantages of mobile pallet racking in narrow-aisle warehouses:

- ▶ Optimum utilisation of space by saving on aisle space
- ▶ Compact storage system reduces energy and operational costs
- ▶ Direct access to all items
- ▶ Enhanced safety thanks to light barriers, release switch and emergency disconnect switch
- ▶ Can also be used in cold store areas
- ▶ Greater efficiency: with mobile racking connected to a WMS, the working aisle is already opening on approach



Carriage with guide profile:

The VNAs are guided along the carriages with the help of guide profiles. The carriage is also bevelled at the outer corners to help it slot smoothly into place.



Precise positioning: When using a VNA, the exact positioning of the carriage is particularly important. This is achieved through a combination of sensors, limit switches and stoppers. In addition, the drives are equipped with frequency converters and multi-disc brakes.

Maximum space for Deutsche Bahn: optimum use of a site spanning over 600,000 m².

CHALLENGE

- ▶ Limited building space in Berlin
- ▶ Creation of a storage solution with a maximum number of pallets in a small space
- ▶ Increased maintenance fleet and the associated increase in space requirements
- ▶ Increasing the availability of spare parts for reliable order processing

SOLUTION

- ▶ Jungheinrich modular, mobile racking system with capacity for growth in the future
- ▶ Precisely tailored narrow-aisle solution with seven carriages for optimal use of space
- ▶ EKX 412 narrow-aisle truck for economical stacking and removal of pallets
- ▶ Galvanised mesh with a small mesh size to reinforce the pallet racking

PROJECT IN FIGURES

Approx. **440 m²**
of space utilised

7 carriages

1 EKX 412 narrow-aisle truck

1,568 pallet storage locations



More information about this successful project can be found **here** on our YouTube channel!



Kill two birds with one stone: our powerful and efficient EKX tri-lateral stackers can be used to stack and retrieve entire pallets in pallet racking systems or to pick individual items from our high bay shelving.



If you value maximum picking performance, you can combine our high bay shelving with the EKS medium/high level order picker.

Our system consultants support you when choosing the appropriate racking system, along with suitable trucks as required.

High bay shelving.

The efficient storage solution for small parts.

If you would like to house lots of different small parts in a tight space, choose modular high-bay shelving to utilise the full height right up to the warehouse ceiling. As an order-picking store for smaller packing units, high-bay shelving is the ideal expansion to a narrow-aisle warehouse for pallets, as you can use the same forklift truck to serve both solutions. The comprehensive range of accessories and the simple components enable tailored adaptation to your goods. The plug-in system also makes the shelving flexible in terms of height adjustment. Heights of over 14 metres are possible in high-bay shelving. This means that high capacities are still possible, even with a small footprint. What's more, the system works seamlessly with our EKS medium/high level order pickers. You can therefore obtain racking and order pickers from a single source.

Advantages of high bay shelving:

- ▶ Quick access to any item
- ▶ Can be adapted to all manner of requirements with a wide range of accessories
- ▶ Excellent space utilisation
- ▶ Easy to assemble
- ▶ Combines with our EKS medium/high level order pickers to form a perfect complete system

High bay shelving components and accessories.

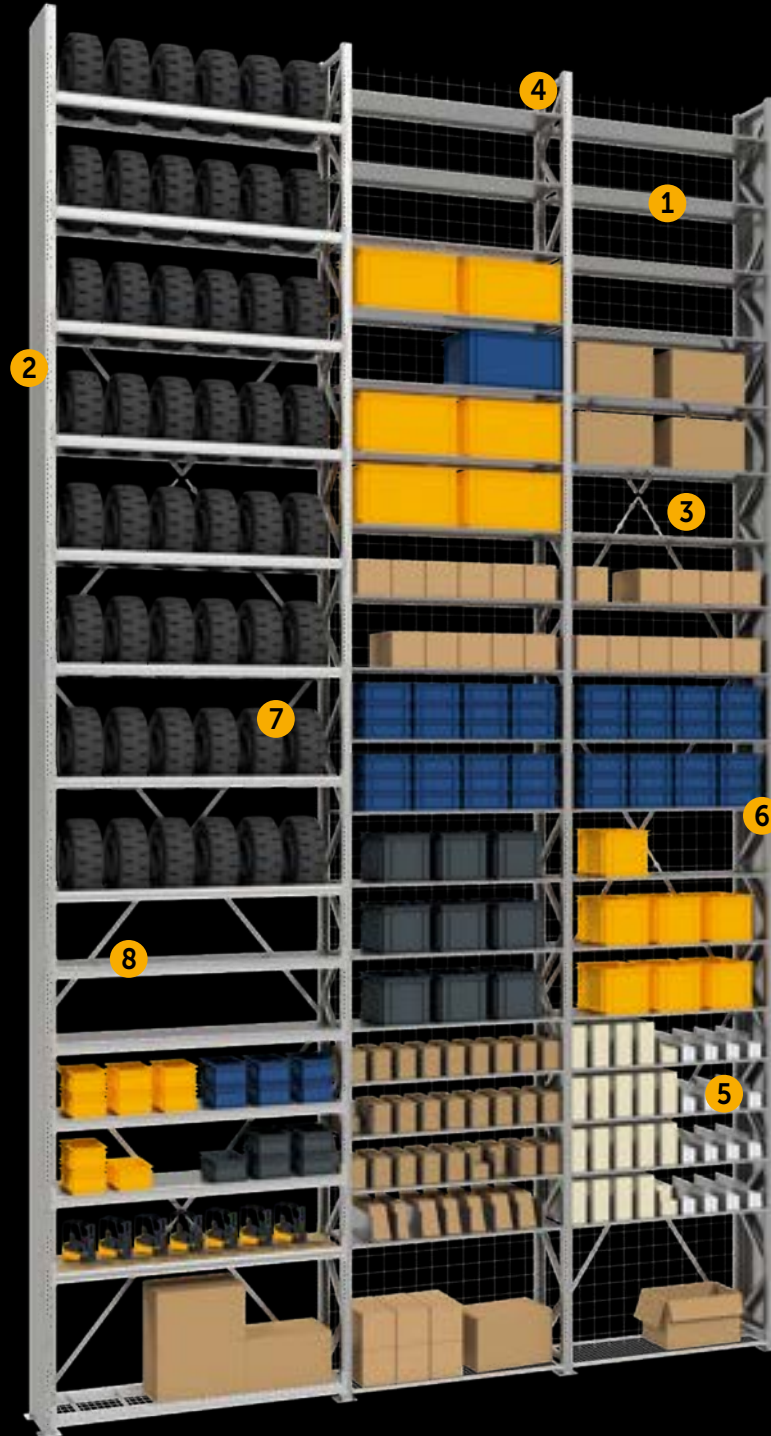

1 SHELVING



Steel-plate shelving:

- ▶ Shelf depth from 300 to 800 mm
- ▶ Shelf length from 750 to 1,700 mm
- ▶ Shelf load up to 300 kg



Mesh shelving:

- ▶ Made from wire mesh
- ▶ Ideal fire protection solution (sprinkler-permeable)
- ▶ Shelf load up to 200 kg
- ▶ Edge height from 25 to 40 mm

2 SIDE WALL



Mesh side wall:

- ▶ Upright frames are covered with wire mesh
- ▶ Prevents stored goods from falling out



Solid sheet metal side wall:

- ▶ Upright frames are completely enclosed
- ▶ Prevents stored goods from falling out
- ▶ The front of the racking rows can be coloured

3 REAR WALL



Solid sheet metal rear wall:

- ▶ Completely enclosed to the rear
- ▶ Prevents stored goods from falling out



Mesh rear wall:

- ▶ Rear walls are covered with wire mesh
- ▶ Prevents stored goods from falling out



Diagonal bracing:

- ▶ Reinforces the rack
- ▶ Helps with alignment during assembly
- ▶ Alternative for double-sided use: longitudinal bars

4 UPRIGHT FRAMES



Flexible design options:

- ▶ Various designs depending on the application
- ▶ Up to 14,500 mm in height
- ▶ Bay loads up to 7.5 t
- ▶ Grid height for shelves 25 mm

5 COMPARTMENT DIVIDER



Segmentation of shelves:

- ▶ Different versions available
- ▶ Flexible adaptation to the stored goods

6 SHELF SUPPORT



Simple plug-in assembly:

- ▶ Incremental height adjustment
- ▶ Individual adaptation to the stored goods

7 TYRE RACKING



Tyre racking version:

- ▶ Two beams for the tyres
- ▶ With back stop
- ▶ Double-depth storage with roll-over plate available

8 LONG-SPAN RACKING VERSION



With steel panels:

- ▶ For heavy and bulky good without pallets
- ▶ Bay length up to 3 m
- ▶ Shelf load up to 1 t



With chipboard:



With wire decking:

Shuttle compact storage.

Smart system solutions for maximum utilisation of space.

Shuttle compact storage combines optimum space utilisation with very high item throughput. Under pallet carriers (UPCs) travelling independently in the pallet channel are the core component of our shuttle compact storage systems – a complete solution consisting of the channel racking, carrier truck and carrier. The huge advantage of this system is that the shuttle travels independently of the carrier truck underneath the stored pallets in the channel, allowing the carrier truck and shuttle to work in parallel. Shuttle systems ensure high throughput rates in high-growth environments with a low to medium variety of items. Typical applications include deep-freeze stores, buffer warehouses and restocking warehouses.

Advantages of shuttle compact storage:

- ▶ Compact storage for optimum utilisation of space and area
- ▶ High throughput
- ▶ Different pallet types can be used in the same racking system
- ▶ Careful load handling
- ▶ Both LIFO and FIFO are possible
- ▶ Simple connection to your Warehouse Management System via our Jungheinrich Logistics Interface



The Jungheinrich UPC can be flexibly adapted to your application scenario.

Clever automation solution for Maintrans Logistik GmbH: space-saving warehouse logistics for Erfurter Teigwaren GmbH, Germany's largest pasta plant.

CHALLENGE

Production never stops in the new finished-goods warehouse at Erfurter Teigwaren GmbH, operated by Maintrans Logistik GmbH. 24/7 operation is essential in order to achieve the high production output required to meet the demand for penne, fusilli etc. The aim of the project was to boost process efficiency and productivity considerably – despite the restriction on space available. Automating and digitising processes should provide the way through.

SOLUTION

Jungheinrich developed an innovative system solution for Maintrans, the project's general contractor. The solution comprised semi-automated shuttle compact storage and mobile robots. Shuttles and manual trucks are connected via Wi-Fi to enable significant increases in efficiency. The workload of personnel is also relieved through the use of fully automated industrial trucks. The award-winning Jungheinrich Logistics Interface ensures flawless communication between the WMS and the warehouse components.

PROJECT IN FIGURES

7,150 m²
warehouse

26,000 pallet
storage locations in the semi-automated shuttle compact storage

6 under pallet carriers
for efficient storage and removal

2 mobile robots
(EKS 215a) for automated pallet transport

3 reach trucks (ETV 320)
with semi-automated lift height selection

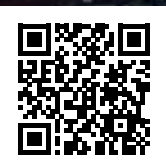
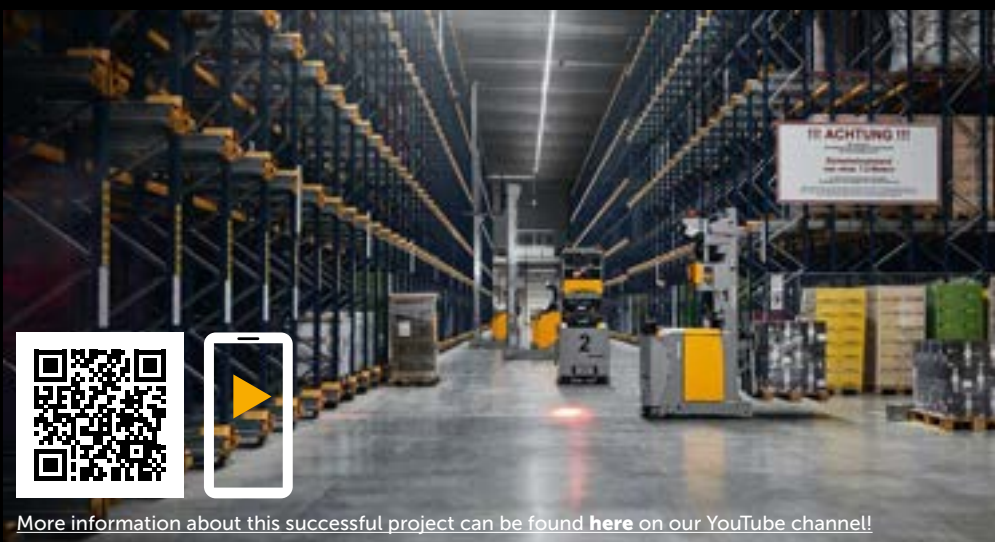

More information about this successful project can be found [here](#) on our YouTube channel!

Layout.

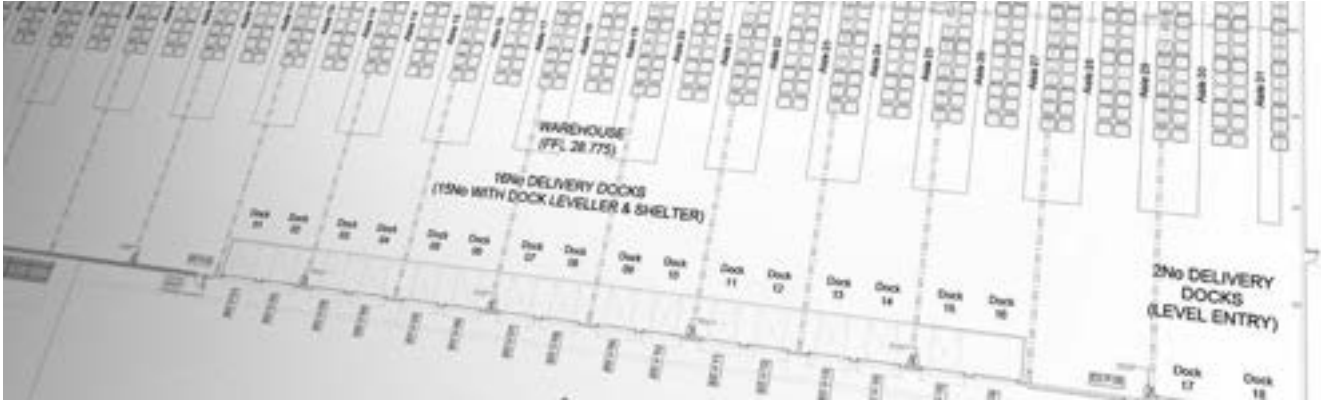

Warehouse floor plan.

SINGLE AND DOUBLE RACKS

High-bay racking is available in single or double-rack variants. While the operator only works on one side of a single rack, both sides of a double rack must be accessible. The exception is double-depth storage, where two pallets are placed one behind the other. This variant is compatible with high-rack stackers to only a limited extent.

Single racks are usually positioned in front of a wall, while double racks are positioned in the centre of the racking system.

The layout of a racking assembly made up of single and double racks is determined by the usable floor space, the load dimensions and the necessary safety clearances, the aisle widths and the column / support grid of the building that has to be integrated into the racking system.

In existing buildings, the racking system is adapted to the framework that is already in place.

When it comes to planning for a new building, the aim is to design an optimised solution. The architect can design the shell of the building to fit perfectly around the racking system. Provided, of course, that plots of land are of sufficient size and shape and there are no restrictions on building height. A support grid is designed to accommodate the racking installation.

SAFETY CLEARANCES – FREE SPACE IN THE RACK

EN 15620 defines clearances as follows: Clearances are the required nominal dimensions of the distances between moving and stationary parts of the system, the purpose of which is to prevent a collision in the event of an unfavourable combination of all relevant tolerances and deformations.

These distances can include:

- ▶ Distances between the loads (x2)
- ▶ Distances to racking uprights (x1)
- ▶ Distances to beams (y)
- ▶ Distances to structural equipment (sprinklers, pipes, cable bridges, lighting, supports, etc.)

The specified distances are limited by the following conditions:

- ▶ Weight and dimensions of loads
- ▶ Height level of the highest beam in the rack
- ▶ Type of narrow-aisle trucks used (man-up or man-down)
- ▶ Degree of truck automation
- ▶ Assistance systems used (warehouse navigation, lift height selection, automated stacking / removal)

The clearances are defined as minimum dimensions. Where appropriate, the distances are regulated by the locally applicable guidelines and standards.

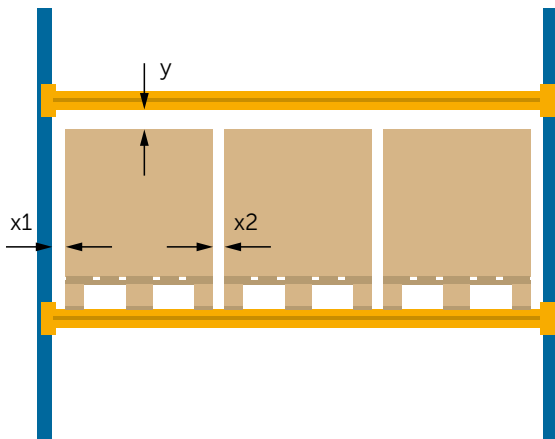

Safety clearances in the rack.

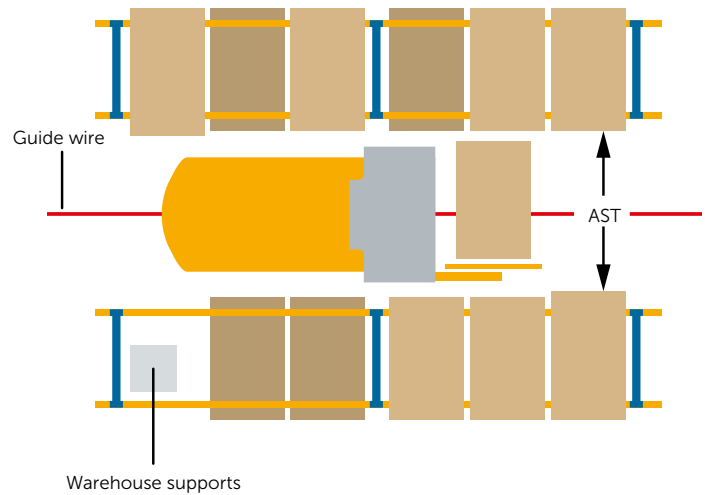

Working aisle.

PASSAGES THROUGH THE RACKING

Appropriate safeguards must be in place if passages are provided in the rack for controllers. The width of the passage is based on the transfer aisle width. The clear height is the result of the maximum height of the devices used in a retracted position plus a safety clearance of at least 250 mm.

The end stands of the passage must be provided with corner protection, and storage above the chassis must have an appropriate cover. To ensure the passage is accessible only with the mast retracted, the narrow-aisle trucks can be equipped with a travel cut-out and lift cut-out.

WORKING AISLE

The calculation of the working aisle (clearance between the racks or the loads stored in the rack) is covered in detail in the "Guidance systems" section.

When setting up the racks, the maximum protrusions of the load over the loading device must be taken into account. In the case of pallet cages, there may also be a flap that is open for order picking, which affects the layout. In existing buildings, care must be taken to ensure that existing supports and other building parts or installations do not protrude into the working aisle (AST).

TRANSFER AISLE

The transfer aisle (AST 3) is designed to allow a narrow-aisle truck to move smoothly from aisle A to aisle X. Clearance for the AST 3 results from the length of the respective type of device including the largest load plus an additional dimension, depending on the type of guidance system (minimum dimensions: 1,000 mm for wire guidance, 500 mm for rail guidance).

In individual cases, a larger transfer aisle may be recommended depending on the conditions. The planning objective is always to achieve quick, smooth and safe aisle changes. Preparation areas for merchandise and goods as well as traffic areas for other trucks must also be taken into account when planning the transfer aisle.

In the case of large racking systems, several transfer aisles can be incorporated to optimise working cycle times. Transfer aisles can be incorporated on both ends of the racking system, or an additional transfer aisle can be added in the centre of the racking system where necessary.



Transfer points.

TRANSFER POINTS

Transfer stations at the front of the racks have the task of preparing the loads for the narrow-aisle trucks. Depending on the loading devices, the transfer points can have different characteristics. In the simplest scenario, the loads are placed at ground level in a marked area in front of the rack. The number of transfer points or the maximum beam height of the transfer points depends on the delivery vehicles used in the narrow-aisle warehouse.

Spaces that are not used for transfer points can be used as normal storage locations. The areas above the transfer points must be protected against falling loads.

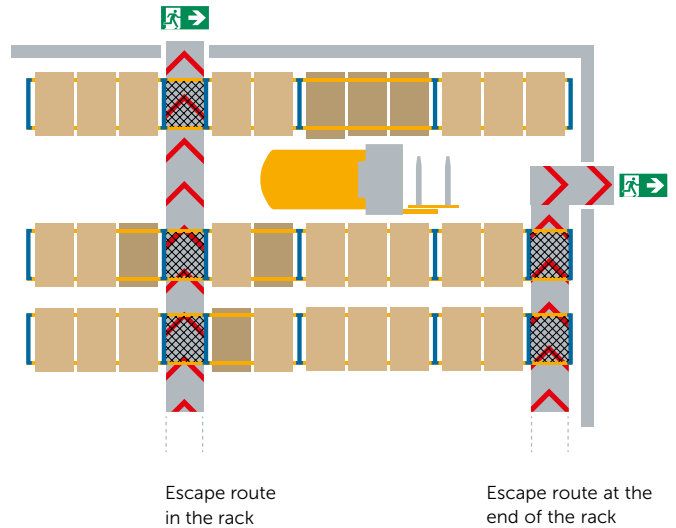
Escape route
in the rackEscape route at the
end of the rack

Escape routes.

ESCAPE AND RESCUE ROUTES

The distance from any point within the warehouse to the nearest fire zone or to an open space must not exceed a direct path of 30 m or a walking distance of 50 m. In Germany, the distances are defined by DIN 4102, but may differ according to the building regulations of the individual federal states. If an escape route must pass through the racking system to comply with the maximum distance, the following design criteria must be observed:

According to the Workplace Ordinance, the aisle width of the escape route must be determined by the number of people working in the area served. A clear aisle width of at least 0.87 m is required for up to 5 people and at least 1.00 m for up to 20 people. The clearance height must be at least 2.10 m. Misuse of the escape routes by personnel must be prevented.

Notices or signs must ensure that the paths are not blocked or obstructed.

If the only possible escape route is at the end of a racking aisle, escape doors or a route across the aisles must be provided. Shelving above the escape routes must be protected against falling load units and goods falling through.



Sprinkler system.

FIRE PROTECTION IN THE RACK

Fire protection measures in the warehouse are a crucial safety element. The members of the construction team would benefit greatly from early discussions with the responsible insurance organisations, approval authorities and the relevant companies.

Sprinkler heads must be placed in protected locations in the rack. Appropriate precautions must also be taken for the piping and fastenings of the sprinkler lines. The space required for the fire protection equipment must be factored into the safety clearances.

CLASSIFICATION OF PROTECTION AREAS ACCORDING TO FIRE HAZARDS

In order to calculate the dimensions of a sprinkler system, a fire hazard class must be determined before planning begins. The fire hazard class is primarily determined by the VdS CEA 4001 guidelines (planning and installation of sprinkler systems).

The buildings and areas to be protected are assigned to one of the following hazard classes according to their use and applicable fire hazards:

LH	Light fire hazard
OH	Ordinary fire hazard Corresponding protection areas are divided into classes OH1 to OH4.
HHP	High fire hazard, risk relating to processing Corresponding protection areas are divided into classes HHP1 to HHP4.
HHS	High fire hazard, risk relating to storage Corresponding protection areas are divided into classes HHS1 to HHS4.

The fire hazard relating to stored goods depends on the combustibility of the stored material, the packaging and the warehouse type.

Requirements for installation.



FLOORING

The correct functioning of a racking system can be guaranteed only if the floor at the installation site complies with the relevant technical standards as outlined below.

LOAD-BEARING CAPACITY OF THE FLOOR

In accordance with the regulations DIN EN 15512, DIN 15629 as well as the information in DIN EN 15635, installation surfaces for warehouse equipment and trucks must be able to safely withstand the service weights and permissible loads.

The maximum contact pressure of the floor must not be less than the value indicated on the racking system. The purchaser and/or operator of the racking system must guarantee that the floor is able to withstand the loads on the racking uprights.

The maximum surface load of the entire area covered and the point load of the forces introduced via the stand feet must be taken into account.

The bay load is the sum of all shelf loads attributed to a beam length, with the exception of the stored goods that are placed directly on the floor. The sum of all shelf loads must not exceed the permissible bay load. The load on the post or upright is derived from the bay loads introduced from the right and left.

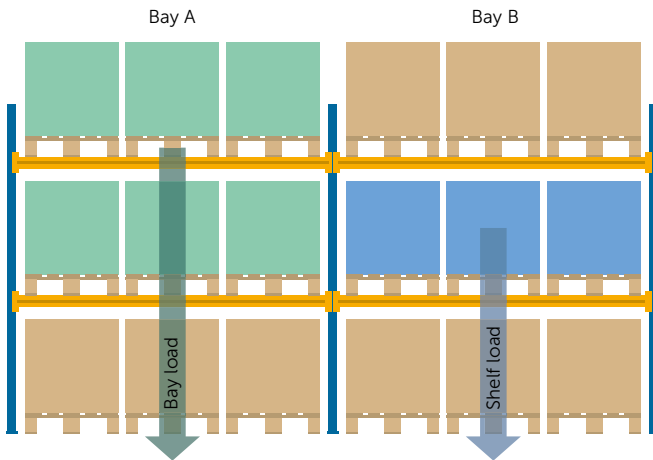

Bay load and shelf load.



Installation.

FLOOR QUALITY

A minimum concrete quality of C20/25 with corresponding reinforcement (DIN EN 206-1 / DIN 1045-2) is required for the warehouse floor. The floor must be at least 20 cm thick and permit ground anchoring with expansion plugs; drilling depth is approximately 15 cm.

Increased drill wear is to be expected with reinforcement diameters (reinforcement steel mesh) exceeding 8 mm and/or reinforcing bars positioned above one another.

Special protection measures are required for abrasive or magnesite-bonded floors to prevent corrosion.

FLOOR TOLERANCES

The flatness of the warehouse floor must comply as a minimum with the structural engineering tolerances indicated in DIN 18202 Table 3 (see "Flooring" section), and in the event of deviations, with the racking classifications specified in EN 15620.

FLOOR DEFLECTION

When constructing racking systems, the deflection can have a considerable influence on the function of warehouse equipment, particularly on ceiling voids. For stationary warehouse equipment, the maximum deflection, based on the largest span, must not be greater than $0.75 \times l/500$.

INSTALLATION

Before setting up the uprights, bolted systems must be pre-assembled. Pre-assembly must take place in an open, heated and well-lit space.

The installation areas must be readily accessible for the final assembly of the racking system. Some installation tasks, such as laying the wire guidance floor system, must only be carried out after the assembly of the rack to ensure compliance with the required tolerances.

With large systems, some installation tasks can be carried out on a rolling basis. Once a section of the rack has been set up, other contractors can start work.

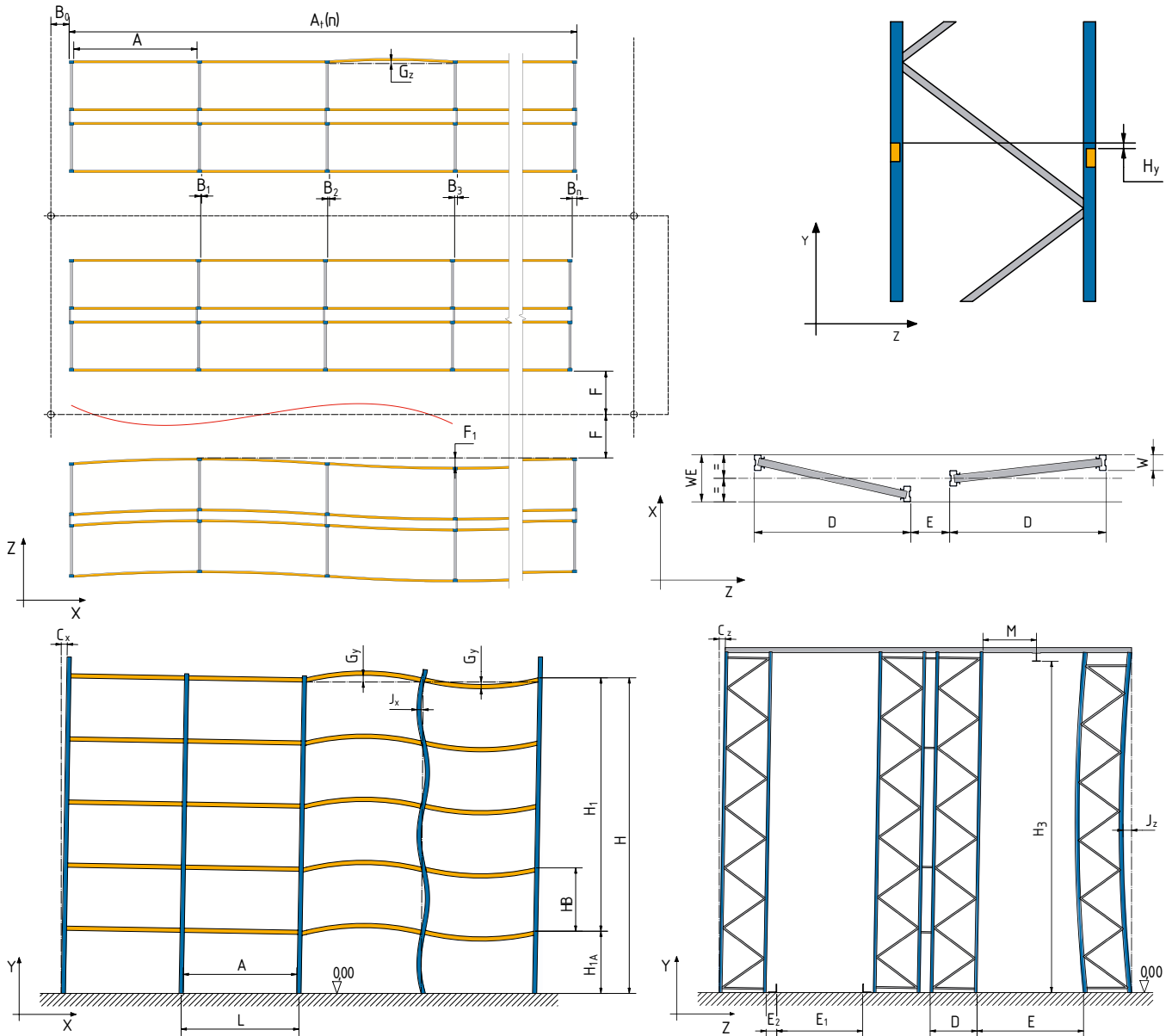

Installation tolerances and permissible deformations of the racks and guidance systems in accordance with EN 15620.

INSTALLATION TOLERANCES

- A Clear access width between two supports
- $A_t(n)$ WE of the overall length of the rack (consisting of "n" bays)
- B_0 Distance to the reference plane of the system
- B_1, B_2, B_3, B_n Misalignment of rack supports across an aisle in bays 1, 2, 3 or "n"
- C_x Deviation of the support from the perpendicular in the Z or X direction
- D Racking depth (frame)
- E Aisle width
- E_1 Distance between guide rails
- E_2 Distance between the guide rail and the front of the support
- F Distance between the reference line X of the aisle system and the front of the support
- F_1 Deviation between adjacent supports, measured approximately at ground level in the Z direction
- G_z, G_y Straightness of the beam in the Z or Y direction
- H Height from the top of the footplate level to the top of the support
- HB Height from the top of the board level to the next highest board level
- H_y Difference in the heights of the pallet receiving points between the front and rear beams in a bay
- H_{1A} Height from the top of the lower beam level to the top of the footplate level
- H_1 Height from the top of the footplate level to any other board level
- H_3 Height from the top of the footplate level to the bottom of the uppermost guide rail
- J_x Straightness of supports in the X direction between adjacent beams
- J_z Initial straightness of an upright frame in the Z direction
- L Distance from the centre to the centre of the supports
- M Distance from the front of the support to the top edge of the guide rail
- W The support width
- WE The tolerance range for opposing frames resulting from the misalignment of the uprights, the deviation of the supports from the perpendicular and the curvature of the support profiles

TABLE 7: EXCERPT FROM EN 15620

Horizontal tolerances for the XZ plane (mm)

Measuring specification and description of the tolerances		Installation tolerances for racks with very narrow aisles
δA	Deviation from the nominal dimension for the clearance between two supports in beams of any height	± 3
δAt	Deviation from the nominal dimension for the overall length of the rack, cumulative for the number "n" of bays, measured approximately at floor level	± 3n
		The larger of the following values applies:
B	Misalignment of the supports on the opposite sides of an aisle, cumulative for the number "n" of bays, measured approximately at floor level	± 10
	With the operator in a raised position, this only applies to the aisle supports	± 1.0 n
	With the operator in a raised position, this applies to the aisle supports and the rear supports	± 0.5 n
δBo	Deviation from the nominal dimension of the racking depth or the end of the transfer station, based on the respective "reference plane of the racking system", measured approximately at floor level	± 10
Cx	Deviation of the support from the perpendicular in the X direction	± H/500
Cz	Deviation of the support from the perpendicular in the Z direction	± H/500
δD	Deviation from the nominal dimension for the racking depth	
	Single frame	± 3
	Double frame	± 6
δE	Deviation from the nominal dimension for the aisle width approximately at floor level	± 5
δE1	Deviation from the nominal dimension for the width between the guide rails	See FEM 10.2.14-1 / 4.103-1 (1)
δE2	Deviation between the supports on one side of the guide rail	± 5
δF	Deviation from the nominal dimension for aisle straightness, measured approximately at floor level in relation to the "aisle system reference line X" or the specification of the truck supplier	± 10
F1	Deviation between adjacent supports, measured approximately at ground level in the Z direction	± 5
Gz	Straightness of beam in Z direction	± A/400
		The larger of the following tolerance values applies:
Jx	Straightness of supports in the X direction between beams placed at a distance HB apart	± 3 or ± HB/750
Jz	Initial curvature of an upright frame in the Z direction	± H/500
δM	Tolerance for the upper guide rail	Set by the author of the requirements document or truck manufacturing company
Tw	Beam twist in the centre of the bay	1°

Note: FEM10.2.14-1 / 4.103-1 provides further information on this topic.

TABLE 8: EXCERPT FROM EN 15620

Vertical tolerances in Y direction (mm)

Measuring specification and description of the tolerances		Installation tolerances for racks with very narrow aisles
		The larger of the following values applies:
Gy	Straightness of the beams in the Y direction	± 3 or ± A/500
δH1A	Deviation of the top of the lower beam level compared with the footplate	± 7
δH1	Deviation of the top edge height of any beam H1 compared with the bottom of the beam height	Operator in a raised position: ± 5 or H1/500 Operator in a lowered position: ± 3 or H1/1000
δH3	Tolerance for the upper guide rail, if any	Specified by the planner or the truck supplier
δHy	Deviation in the pick-up heights of the load units between the front and rear beams in a bay	± 10

The tolerance range for opposing frames, which results from the offset of the supports, the deviation of the footplates from the perpendicular and the curvature of the support profiles, must not exceed WE.

$$WE = W + 2Cx + Bmax + 2Jx$$

WE The tolerance range for opposing frames resulting from the misalignment of the uprights, the deviation of the supports from the perpendicular and the curvature of the support profiles

W The support width

Cx The deviation of the supports from the perpendicular according to Table 7

Bmax 10 mm or 0.5 n according to Table 7

Jx The straightness of the supports between the beam heights given in Table 1

Note: This tolerance helps the operator working on the ground to visually position the pallet using the opposite stacking tiers.

For smooth operation, we recommend adhering to the tolerances CZ both when the racking system is unladen and when it is laden. This is important for maintaining safety clearances in narrow aisles.

Warehouse organisation.

1. Group of numbers:
Racking rows or aisles
Two-digit number from 01 to 99 representing the order of the racking rows / aisles

2. Group of numbers:
Longitudinal position in the rack
Two-digit number from 01 to 99 representing the exact longitudinal position in the rack

3. Group of numbers:
Height position in the rack
One-digit (1-9) or two-digit number (01-99) representing the exact height position in the rack

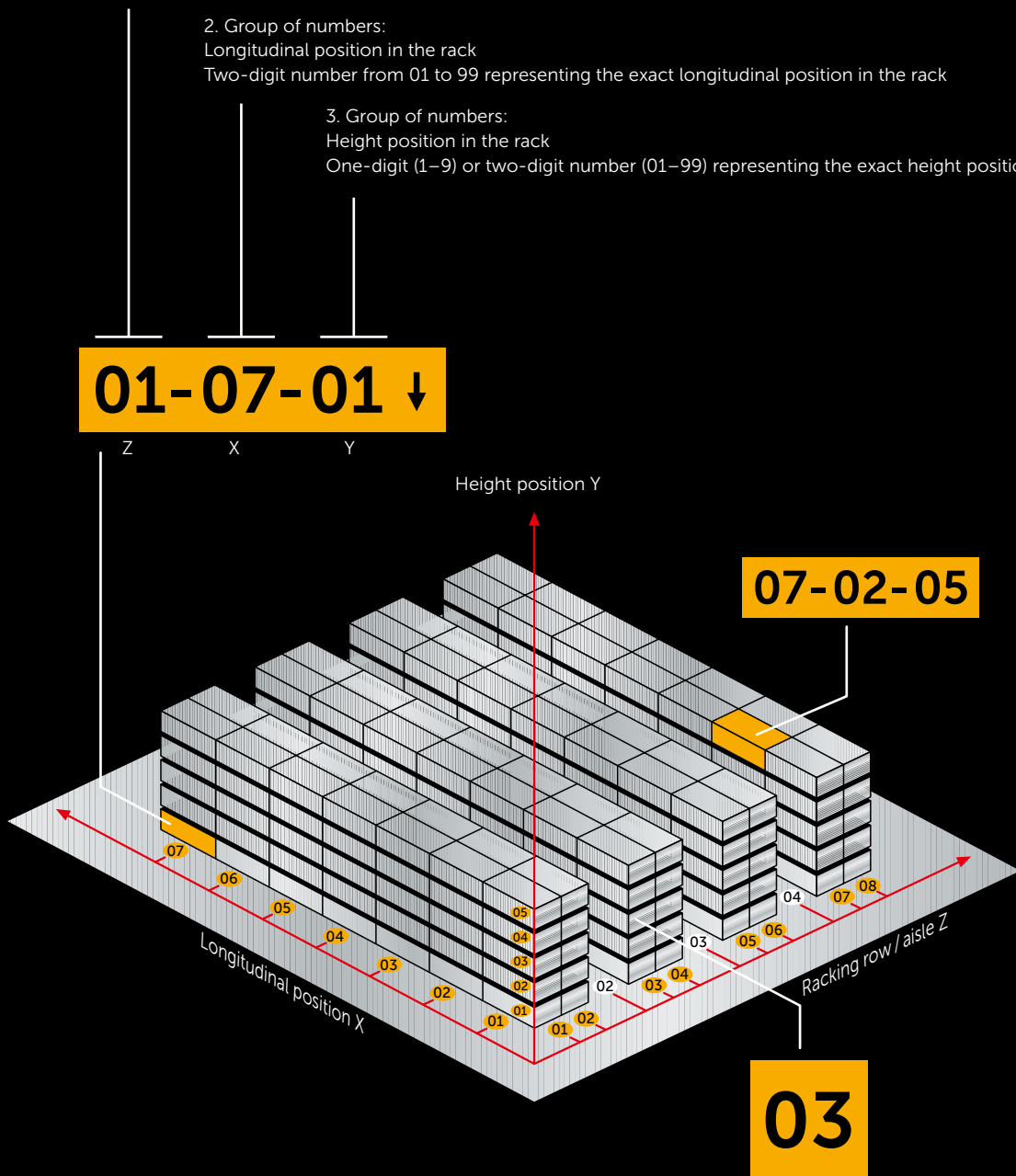

Racking row / rack location numbering for space allocation, ABC classification, route optimisation and inventory management

SELF-ADHESIVE LABELS:



- ▶ Three groups of numbers (maximum of three characters per group).
- ▶ Numeric, alphabetic / alphanumeric.
- ▶ More groups available on request.
- ▶ Barcodes can also be printed.

PLASTIC NUMBER PLATES:



- ▶ Numeric, alphabetic, alphanumeric.
- ▶ Can display a maximum of two characters.
- ▶ Ready to assemble, can be hung without tools.
- ▶ Custom-made products up to 1,000 x 1,000 mm on request.

MAGNETIC C-PROFILES:



- ▶ A proven solution for flexible and mobile identification and labelling.
- ▶ Affix as often as required to all ferrous substrates. Rack fronts, transport boxes, cabinets, machines and tool benches are just a few examples of applications.
- ▶ The C-profiles are flexible and can therefore also be attached to slightly curved surfaces.
- ▶ With these profiles, you will receive suitable label strips (included with cuts) or perforated DIN A4 sheets in cardboard thickness.

LABEL HOLDERS AND STRIPS:



- ▶ Practical if the labels need to be changed often.
- ▶ Can be used with all types of rack, are made from impact-resistant hard PVC and with magnetic or self-adhesive backing available as options.
- ▶ Attaching the labels to the rails is very easy. Subsequent relocation and replacement are just as simple.
- ▶ The barcodes retain their legibility. Use label holders for individual labels or label holder strips for entire rack assemblies.

Play it safe with certified inspectors.

Legislative authorities require regular inspection of racking equipment to ensure continual safety in the narrow-aisle warehouse. Our team of accredited inspectors is on hand for this purpose.

Your warehouse equipment withstands high loads on a daily basis and should be able to keep adapting to your needs. If your range changes, for example, the loads may also change and as a result the structure. Jungheinrich ensures that you remain flexible while staying safe: with standard-compliant warehouse equipment and annual rack inspections as a guarantee of sustainable productivity. For legal reasons, we recommend that you only use original spare parts in the event of damage.

INSPECTION AS PER DIN EN 15635

Our accredited rack inspectors have the necessary expertise to conduct qualified professional inspections in accordance with European standard EN 15635. The annual inspections take place during operation so that you remain productive at all times. The inspection sticker documents that you as an operating company have implemented this safety measure required by health and safety legislation.

The benefits for you:

- ▶ Inspection sticker certifying the inspection
- ▶ Immediate repair using original spare parts
- ▶ Increased safety and productivity in the warehouse

RAL QUALITY MARK: ENHANCED SAFETY

As well as meeting legal requirements, Jungheinrich consistently undertakes to guarantee maximum quality and safety standards. We can demonstrate this through the RAL quality mark. It shows that we have our work regularly monitored by an independent institute right from the production of our warehouse equipment. We also operate our own test centre in Norderstedt near Hamburg so we can put our products through their paces.





This is how the inspection goes.



Racking system inspection in accordance with DIN EN 15635 (use and maintenance of warehouse equipment).



Comparison of the load capacity signage with the actual rack structure.



Check of the construction of the racking system in accordance with the assembly drawing (where available).



Visual inspection of uprights and beams for visible deformation and damage, carried out from the warehouse floor.



Test sticker is issued to certify successful inspection.



Test report is provided.



Offers are submitted as necessary for replacement of damaged parts.

Guidance systems.

On track for success.

Space is a precious commodity in narrow-aisle warehouses. Mechanical and wire guidance systems reduce the distances between racks and trucks, and ensure that goods and racks are not damaged. In accordance with DIN EN ISO 3691-3, the minimum distance between load units on the rack and lift units on the truck is 90 mm. Depending on the type of guidance system, device type and pallet size, larger distances may be required.

Since it is impossible to deviate from the designated course, travel speeds and lift speeds can be maximised to achieve better throughput.

The workload of the operators is also reduced by the guidance systems. They can focus all of their attention on the storage and removal process instead of concentrating on the route. Continue reading to find out more about the advantages of guidance systems and the differences between the two versions, and discover which solution is more suitable for your warehouse environment.



Mechanical guidance.

OPERATING PRINCIPLE

The device is mechanically guided between two steel profiles bolted to the ground. Two rollers are fitted to each side of the chassis, which guide the truck between the rails in the middle of the aisle.

SAFETY CLEARANCE FOR RAIL GUIDANCE

With a safety clearance of just 100 mm, rail-guided trucks are able to achieve optimised results in terms of operational safety and throughput.

The distance between the load wheel and the guide rail should be at least 50 mm. The system should be designed to allow the operators to align the truck easily between the rails (see Fig. 1).

AISLE WIDTH FOR RAIL GUIDANCE

The minimum width for the working aisle (AST) is determined by the stacking depth of the load, the structural dimensions of the chosen type of device and the prescribed minimum safety clearances (see Fig. 2).

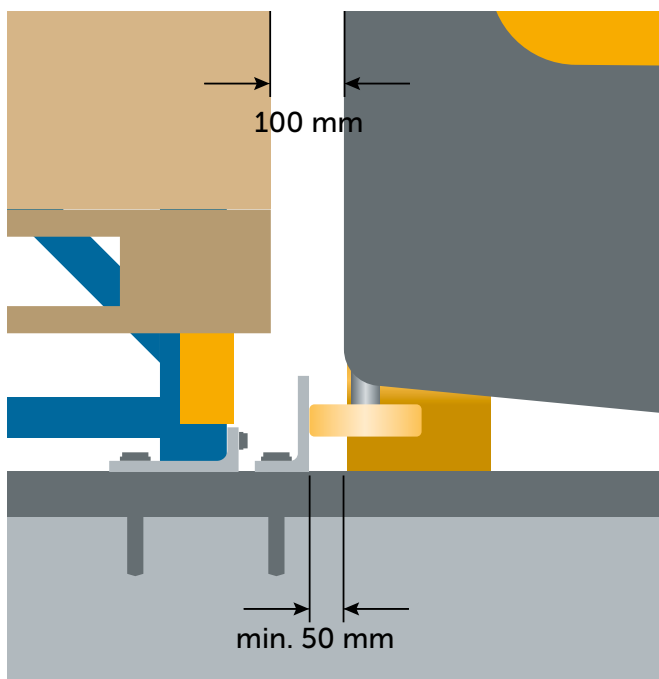
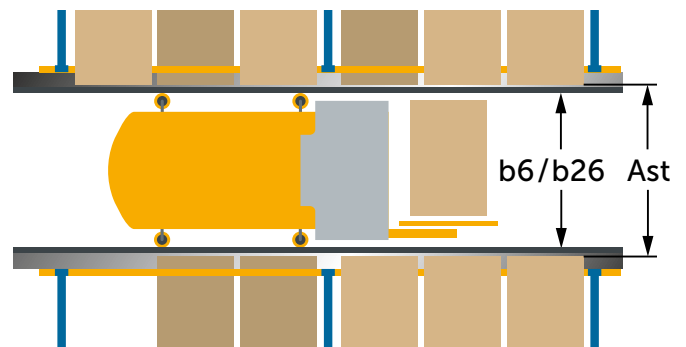
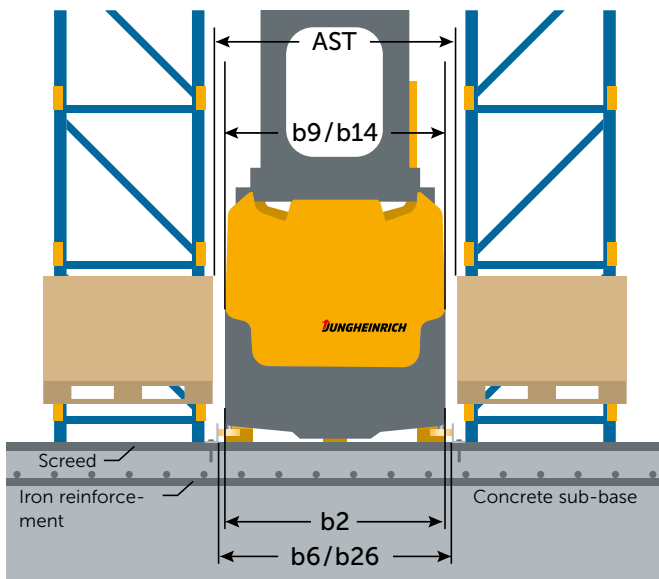

Fig. 1
Safety clearances for rail guidance.



- b2 Load axle width
- b6 Dimension across the guide rollers
- b9 / b14 Cabin / swivelling sideshift frame width
- b26 Minimum dimension between the guide rails
- AST Aisle width

Fig. 2
Safety clearances for rail guidance.

CONSTRUCTION OF RAIL GUIDANCE SYSTEMS (Fig. 3)

The rail guides can be divided into high and low as well as cast and non-cast variants. High rail guides have a profile height of 100 to 120 mm.

A rack with a concrete base is referred to as a cast guide rail. If the loading devices are parked at ground level behind the guide rail, a low rail profile is used.

Depending on the requirements, different profile shapes can be selected according to rigidity, section modulus, contact area and ease of assembly.

Different forces and torques are applied based on truck geometry and the travel speed of the trucks.

These forces are influenced by the levelness tolerances of the floor and are transferred to the rails via the guide rollers. As a rule, the devices have four guide rollers: two in the front and two in the rear of the chassis.

At the entrance to the aisle, the truck is positioned between the rails with the front guide rollers. Since guidance is initially only provided by the front pair of rollers, the greatest stresses occur in the track alignment area. Horizontal forces can be up to 25 kN (F1). The length of the track alignment area is approx. 2,500 mm, after which point the device is also guided by the rear pairs of rollers. The forces in the rest of the aisle are reduced to between 8 and 10 kN (F2).

In order to make it easier for operators to guide the truck into the aisle between the rails, the entrance area is equipped with an entry guide. The entry guide is approx. 300 mm in length with an opening angle of 15°.

Entry guides and entrance areas should always be designed with high profiles to make the alignment process safer.

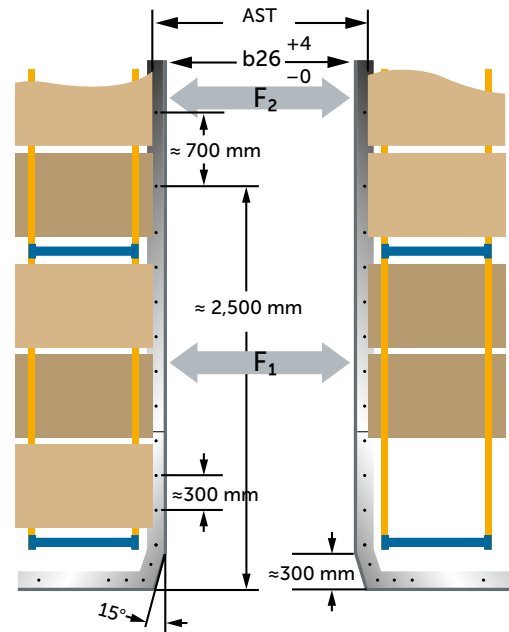

Fig. 3
Assembly of the guide rails.

ASSEMBLY OF THE GUIDE RAILS

The guide rails are laid and anchored in the floor. The various forces in the travel area and track alignment area are offset by altering the distance of the anchors. In the travel area, the distance between anchors can be 600 to 700 mm. In the track alignment area, the distance should be reduced to approx. 300 mm.

The rail joints are welded and ground down during assembly on site. The welds are then protected against corrosion by appropriate surface treatment (see Fig. 3).

EXAMPLES OF VARIANTS

High guide rail, cast (Fig. 4):

- ▶ Floor areas must be kept clean
- ▶ No floor support required
- ▶ The working aisle and the distance between the guide rails can be the same size
- ▶ Large load axle widths with high load capacities can be implemented
- ▶ Absorption of large lateral forces
- ▶ Ideally suited to large lift heights
- ▶ Screeding only possible in travel areas

High guide rail, not cast (Fig. 5):

- ▶ Easy assembly
- ▶ Easy to disassemble for changes in rack layout
- ▶ Floor support required
- ▶ Suitable for small to medium lift heights with low lateral forces

Low guide rail (Fig. 6 and 7):

- ▶ Lifting / depositing from loading devices directly from / onto the floor
- ▶ No floor support required
- ▶ Easy assembly
- ▶ Suitable for small to medium lift heights with low lateral forces
- ▶ Easy to disassemble for changes in rack layout



Fig. 4
High guide rail, cast,
e.g. C profile 120/6.



Fig. 5
High guide rail, not cast,
e.g. L profile 100/65/11.

Note:
A minimum clearance of 15 mm
between the guide roller and the
ground is recommended for smooth
operation.



Fig. 6
Low guide rail,
e.g. U profile 65/42/6.



Fig. 7
Low guide rail,
e.g. L profile 40/60/8.

Wire guidance.

OPERATING PRINCIPLE

The guided truck follows a guide wire routed in the ground. A frequency generator feeds the guide wire with high-frequency alternating current (low voltage). The current generates a concentric alternating electromagnetic field.

Sensors mounted on the truck detect this electromagnetic field. Any change in truck position with respect to the guide wire is therefore recorded. Steering is automatically compensated to ensure that the truck is guided safely along the aisle.

WAREHOUSE FLOOR

The following must be observed when installing iron reinforcements or steel fibres in the ground:

In order to avoid a negative influence on the alternating electromagnetic field, the iron reinforcement (reinforcement steel mesh) must be inserted in the concrete below the guide wire level. A distance of >50 mm between the guide wire and reinforcement has proven effective. If steel fibres are used instead of mesh, an even distribution of the fibres in the concrete must be ensured. The proportion of fibres in the concrete may not exceed 30 kg/m^3 .

Other metallic components, for example steel profiles used to protect expansion joints and movement joints, should not be used within a range of ± 250 mm to the guide wire and should not be positioned parallel to the guide wire. The installation instructions from the Jungheinrich Service team must be observed. The Jungheinrich Service team must also be contacted for a consultation.

The expansion joints can be placed under the racking rows, for example, so there is no stress on the joint edges and the truck (see Fig. 8).

Guide wire detection (antenna)

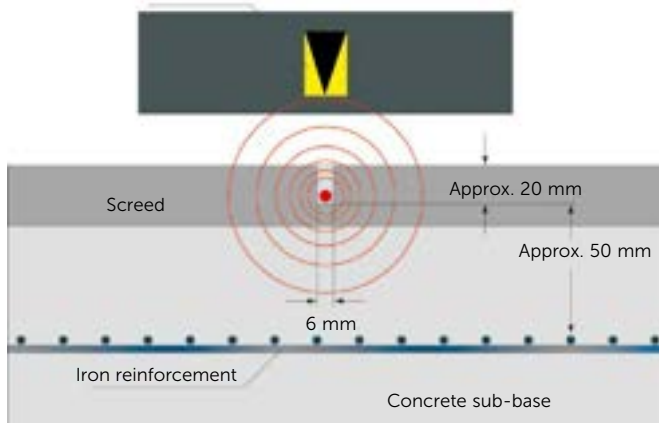

Fig. 8
Guide wire in the warehouse floor.

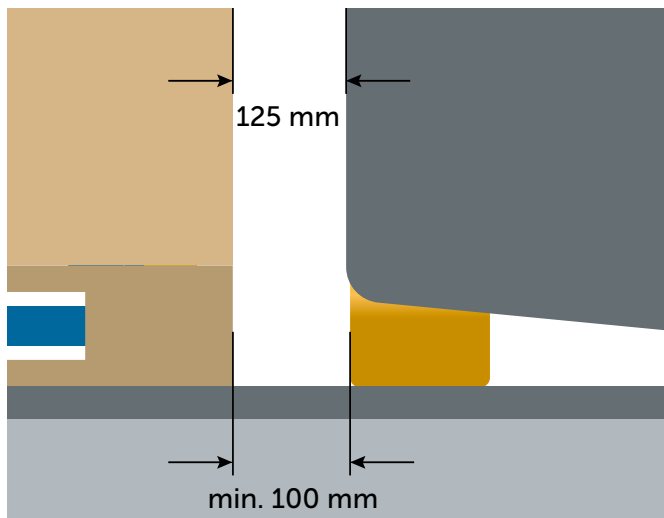

Fig. 9
Safety clearances for wire guidance.

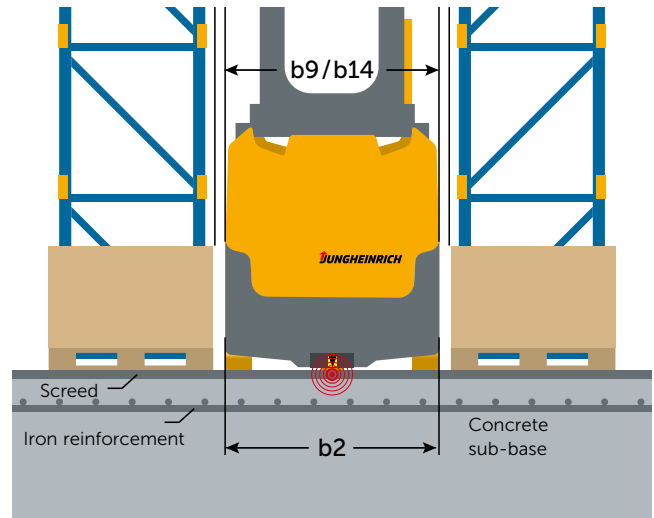

Fig. 10
Aisle width for wire guidance.

SAFETY CLEARANCE FOR WIRE GUIDANCE

With a safety clearance of just 125 mm, wire-guided trucks are able to achieve optimised results in terms of operational safety and throughput. The distance between the load wheel and the rack or the load stored in the rack should be at least 100 mm (see Fig. 9).

AISLE WIDTH FOR WIRE GUIDANCE

The minimum width for the working aisle (AST) is determined by the stacking depth of the load, the structural dimensions of the chosen type of device and the prescribed minimum safety clearances (see Fig. 10).

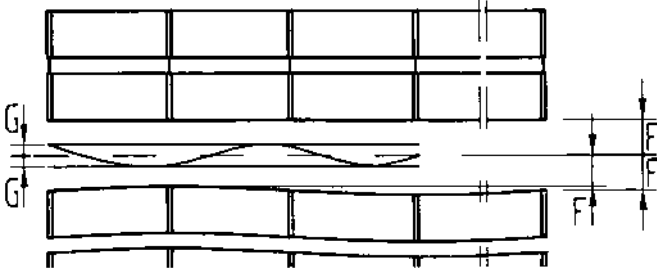

Fig. 11
Installation tolerances and permissible deformations of the racks.



Fig. 12
Frequency generator.



Fig. 13
Inserting the cable.

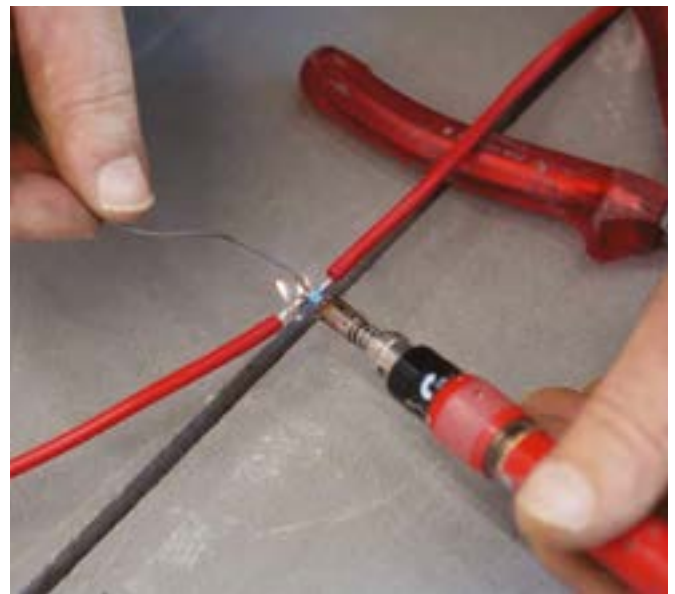

Fig. 14
Soldering the connection points.

GUIDE WIRE

To lay the guide wire, a groove 15 to 20 mm deep and 6 mm wide is milled into the travel surface. The resulting dust is bound with water and suctioned away.

A copper cable is then laid and the groove is sealed again with a sealing compound so that it is level with the floor. In order to prevent the guide wire from tearing when the floor slabs move or expand, it is advisable to cover expansion joints with foam rubber and to use a double-sheathed guide wire. The cable therefore has room to adjust.

If it is not possible to lay the return wire in the floor, the cable can also be laid in an empty PVC pipe installed in the wall or ceiling.

To ensure that the deviation tolerance of the guide wire from the centre of the aisle is not exceeded, the guide wire should only be laid after the racking system has been installed. The deviation of the wire guide line may not exceed ± 5 mm from the centre line of the working aisle over the entire length of the aisle (see drawing).

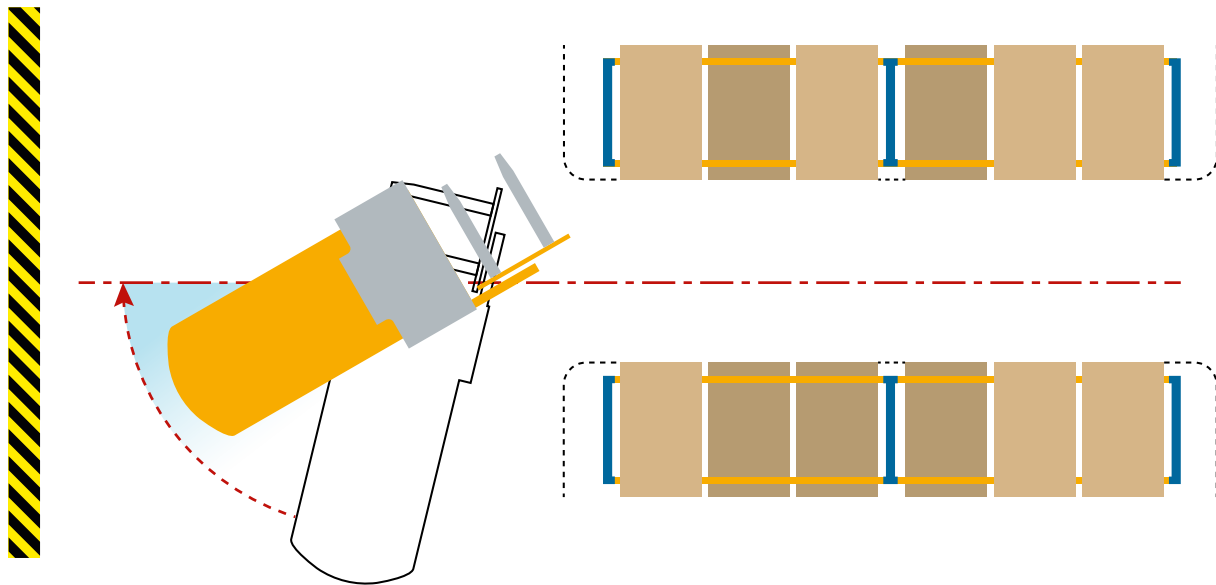

Fig. 15
Track alignment process.

FREQUENCY GENERATOR

A frequency generator feeds the guide wire with high-frequency alternating current. It is possible to connect four individual travel loops to the Jungheinrich WG generator, each with a maximum length of 1,000 m. If a single loop is damaged or fails, the remaining storage areas remain operational.

The frequency generator should be installed in a protected, easily accessible location. If the mains supply is unreliable, an independent voltage source (buffer battery) can be installed as an emergency power supply. The emergency power supply can cover downtimes in the mains voltage for approx. two hours.

A separate circuit with separate protection must be provided for the frequency generator and emergency power supply. The supply voltage is 220 V AC with 50–60 Hz.

Six different frequencies from 4 kHz to 9.5 kHz can be configured. Adjustable loop current can be assigned for any frequency from 25 mA to 120 mA. Up to three different frequencies, for example for the activation frequency, can be modulated onto a loop.

WIRE GUIDANCE WITH HIGH GUIDANCE ACCURACY

Jungheinrich wire guidance systems always feature extremely high precision levels. This is achieved through the three-phase AC steering drive. Adjusted continually and undetectably, it has a significant advantage over traditional hydraulic steering systems with steering that is slow to respond.

ADDITIONAL BENEFITS:

- ▶ Depending on its type, a truck can approach the guide wire up to an angle of almost 90°
- ▶ Saves space in the loading area
- ▶ Short track alignment times
- ▶ High travel speeds on the guide wire
- ▶ Can be adapted to a range of frequencies in the floor system
- ▶ Different frequency levels can be used on one wire

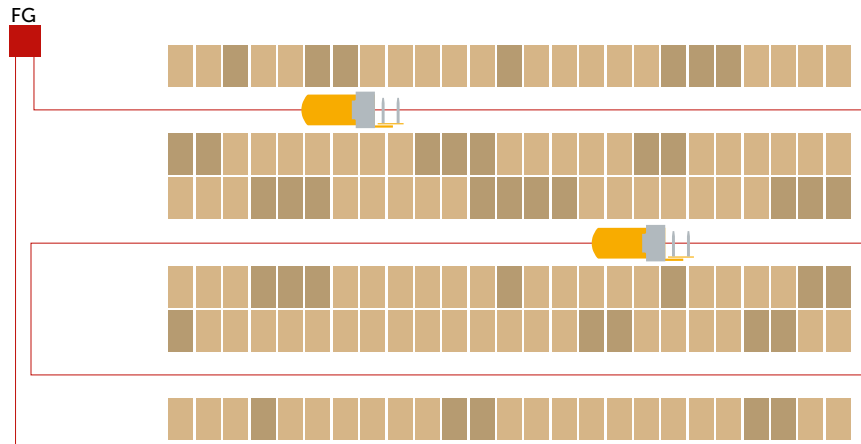

Fig. 16
Guide wire course with an odd number of aisles.

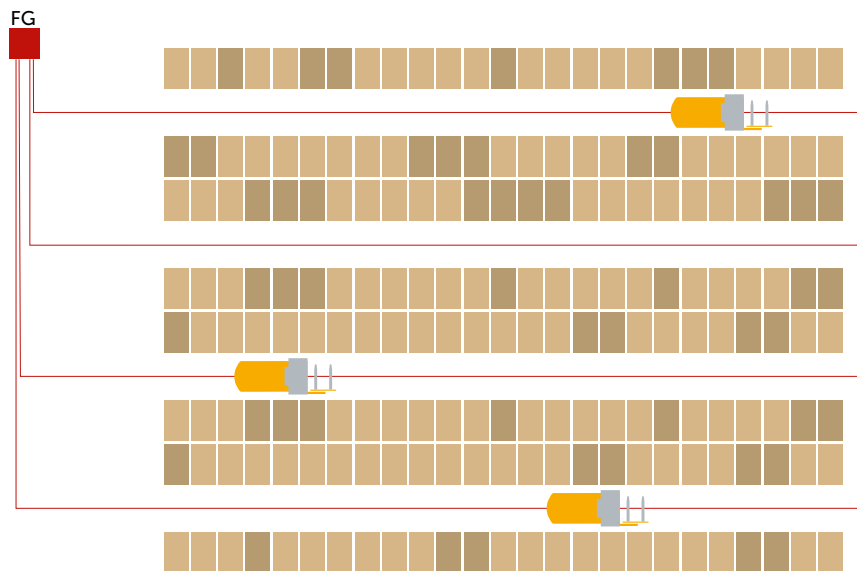

Fig. 17
Guide wire course with an even number of aisles.

GUIDE WIRE COURSES

The wire floor system is laid as a closed conductor loop with the start and end connected to the frequency generator (FG). When an uneven number of aisles is used, an additional return wire must be connected to the frequency generator (Fig. 16).

In order to prevent disruption to the magnetic fields in the guidance area, the distance between guide wires with the same frequency must be 1.5 m. Return wires that are not used as traffic lanes are the exception to this rule.

With an even number of aisles, no additional return wire is required. The illustration shows a layout with two separate conductor loops. If an error occurs in one of the loops, warehouse operations can continue in the other area (Fig. 17).

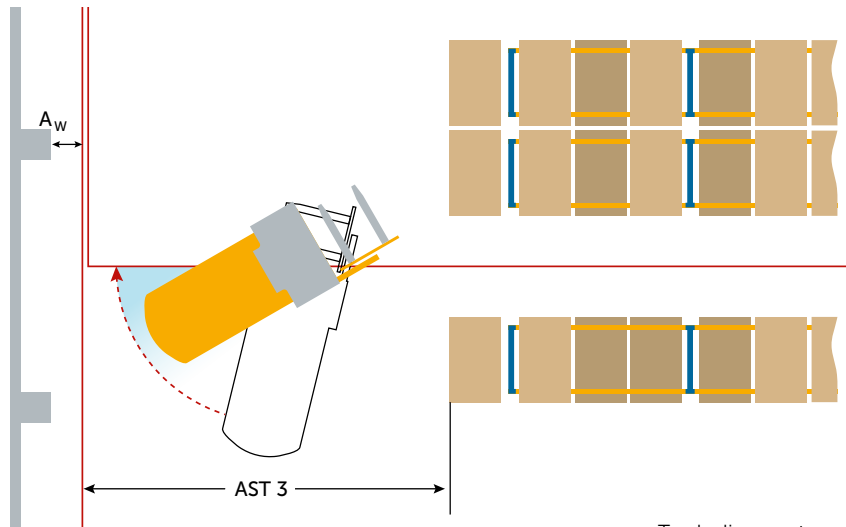

Fig. 18
Track alignment area (transfer aisle).

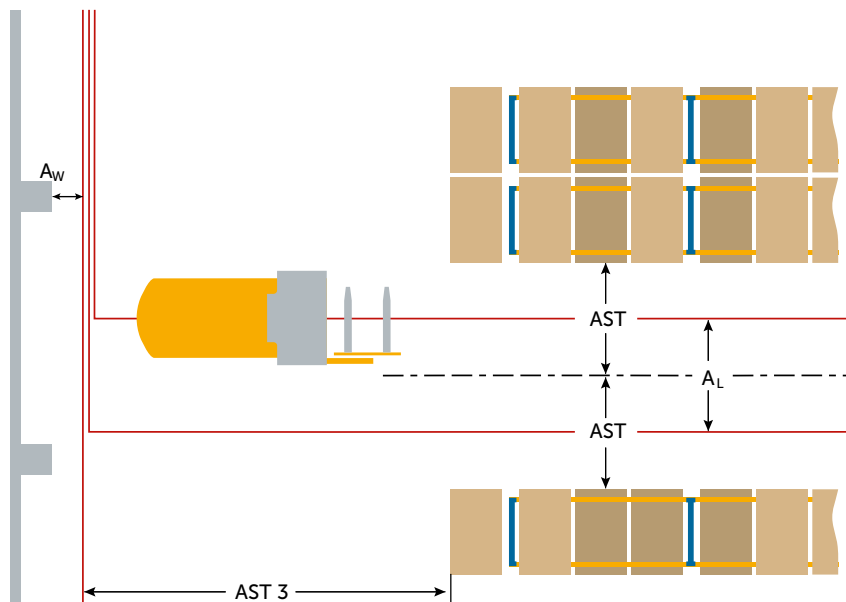

Fig. 19
Wire guidance in wide aisles.

LAYOUT

The wire should be pulled as far as possible into the transfer aisle in order to enable operators to align the truck quickly and easily on the guide wire. The minimum clearance (AST 3) results from the length of the respective type of device including the load plus an additional 1,000 mm (Fig. 18).

The minimum distance of the guide wire from the warehouse wall (A_w) is governed by half the width of the milling attachment plus the existing structures such as supports, sprinkler pipes or other building installations.

If the working aisles run into a dead end, the guide wire should be laid as close as possible to the end of the aisle in order to reach the furthest pallet storage locations without any problems.

Wide working aisles can be divided into two guided areas by laying two contact wires. For example, this may be the case if the warehouse layout was previously designed for the use of front stackers or reach trucks, and the racking configuration remains the same (Fig. 19).

When the same frequency is used in the contact wires, the minimum distance (A_L) must be 1,500 mm. Otherwise, different frequencies are used. The same applies to crossed contact wires.

Safety and assistance systems.

Intuitive solutions for a complex warehouse environment.

Increasingly complex processes and changing dynamics increase potential hazards in the warehouse. That is why sophisticated safety and assistance systems are becoming increasingly important in order to provide effective protection for people, trucks and goods. Our range of solutions in this sector is made by professionals for professionals. Over many decades, we have continued to perfect our safety and assistance systems through constant dialogue with our customers. We are now able to respond effectively to all safety-related issues in the warehouse, with solutions tailored to your industry and your individual needs.

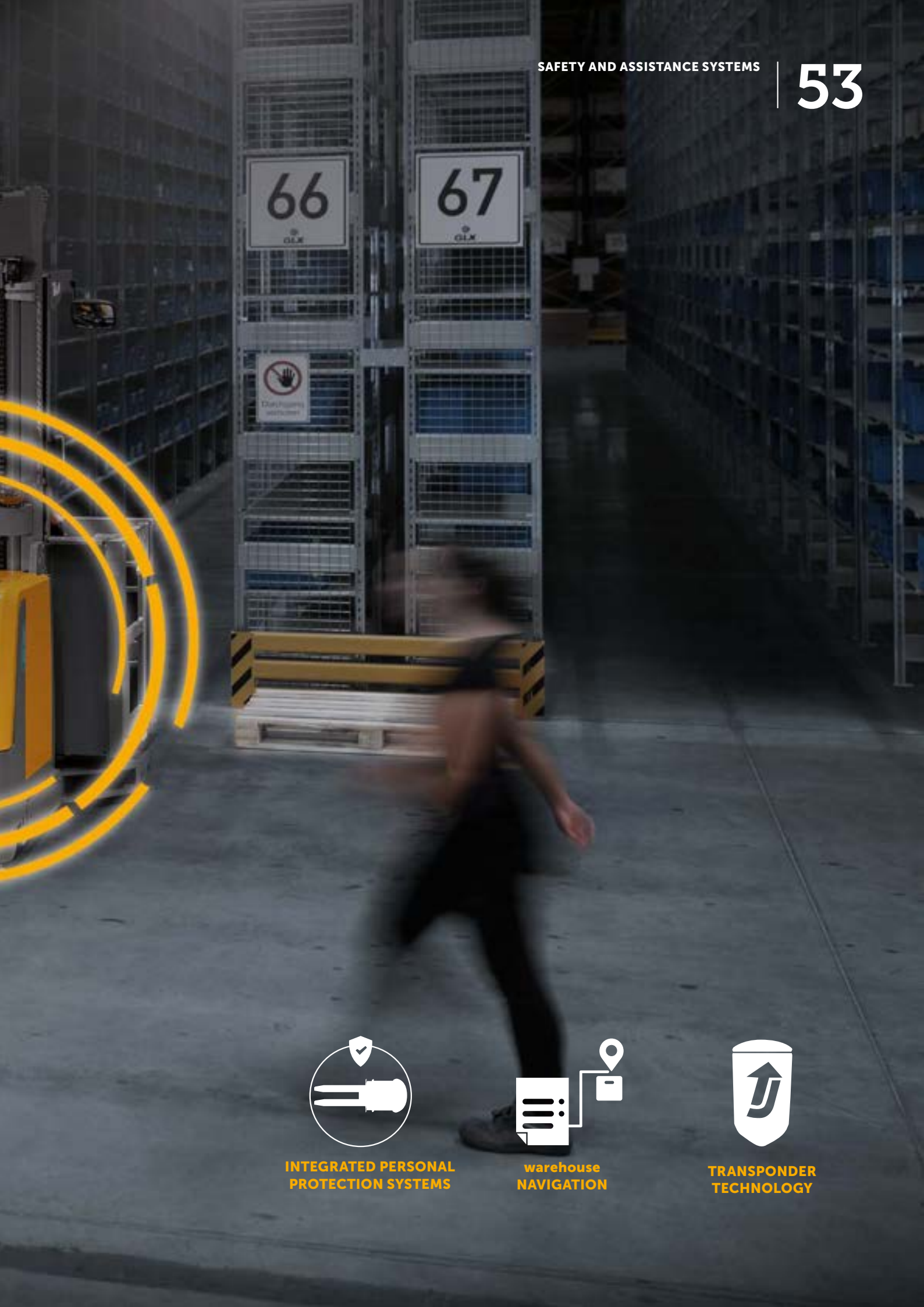

INTEGRATED PERSONAL PROTECTION SYSTEMS



warehouse NAVIGATION



TRANSPONDER TECHNOLOGY

Differences between safety and assistance systems.

Safety is always the focus at Jungheinrich. Safety and assistance systems from Jungheinrich undeniably lead to improved levels of safety. However, there are important differences that must be considered when to choose the right system.

The **safety system** offered by Jungheinrich is the mobile personal protection system (PPS).

Our PPS is a contactless protective device integrated into the truck (performance level in accordance with ISO 13849-1). It meets the requirements of DGUV Regulation 68 and works in conjunction with access protection in narrow aisles. The system independently identifies people in the narrow aisle and brings the truck to a safe stop.

Assistance systems are additional smart devices to support operators in certain operating situations with the aim of increasing safety or efficiency. In contrast to the independent safety systems, the operators retain full control at all times. The assistance systems include various cut-outs, zoneCONTROL and the Jungheinrich warehouse navigation system. A detailed list can be found in the "Assistance systems" section.



Symbol for safety systems (e.g. EKX with PPS installed).

Assistance systems.

Increasingly complex warehouse processes and growing dynamics increase potential hazards in warehouse operations. Thanks to Jungheinrich, you can improve the overall safety of your warehouse – reducing costs and conserving your company's resources along the way.

A wide range of assistance systems is available to provide effective support for operations in narrow aisles. These systems will be explained in more detail in this section.

	ASSISTANCE SYSTEMS (and supporting equipment options)	DESCRIPTION
Improved safety	curveCONTROL	Automatic effect on truck speed depending on the current load and the current steering angle.
	driveCONTROL	Automatic effect on truck speed depending on the current lift height.
	Speed reduction with ground system via transponder	Programming for area-dependent speed profiles via transponders. Can be used to program different travel speeds in the aisles of the warehouse.
	Travel / lift / lower / rotary cut-outs	All truck movements can be terminated by the cut-out function. For example, the cut-out prevents collisions with fixed parts of the building. Multiple cut-outs can be included in one attractive package.
	operationCONTROL	Recording of the current load weight. Warning when impermissible load values are reached or automatic cut-out of the travel, lift or lowering speeds.
	Impact sensor	An impact sensor can be used to determine the truck response to impacts and accidents. When a set threshold value is exceeded, the sensor module is triggered and responds accordingly.
	Warning signals (depending on the travel direction)	Audible warning signal (e.g. depending on the travel direction).
Improved view and visibility	zoneCONTROL	Targeted use of the modular and flexible assistance system enables effective management of potential danger zones posing a high accident risk, such as low passageways, transition areas between buildings or crossings with poor visibility.
	addedVIEW 360° camera system	Camera system consisting of various cameras for a 360° view and a bird's-eye view of the truck.
	Fork camera	The camera image shows the operator the exact position of the fork in front of the rack.
	Various lights and spotlights	Visual warning signal on the truck available in various versions (e.g. spotlight option also available).
Improved efficiency	Floor-Spot	An LED spotlight provides a visual warning of approaching trucks by displaying a coloured light on the floor in front of or behind the truck (switched on automatically during forward or reverse travel).
	Floor Pro	Vibration absorber for travel on uneven floors.
	positionCONTROL	Programmable, automatic lift height selection.
	speedprofilePLUS	Load-dependent control of the speed profiles.
	warehouseNAVIGATION	The WMS transmits the information regarding the next rack location to be visited to the Logistics Interface on the truck terminal. The truck then switches to diagonal travel to approach the target location (semi-)automatically and with utmost precision.
	EasyAccess	Truck access can be controlled without a universal key directly from the truck display. This reliably protects the entire fleet from unauthorised use. Variants: softkey, PIN code or transponder.
	Auto-ID	A barcode scanner on the fork carrier automatically records storage locations and/or goods (can be connected to the WMS as an option).

IMPROVED SAFETY



curveCONTROL.



Speed reduction.



Cut-outs.



operationCONTROL.



zoneCONTROL.



PPS (see Safety systems).

IMPROVED VIEW AND VISIBILITY



addedVIEW 360° camera system.



Camera systems.



LED working lights.



LED operator position lighting.



Order picking lights.



Stack-by-Light.

IMPROVED EFFICIENCY



Floor Pro.



positionCONTROL.



speedprofilePLUS.



warehouseNAVIGATION.



EasyAccess.



Auto-ID.



End of aisle control by transponder.



Travel/lift cut-outs in front of an obstacle (intersecting aisle).

END OF AISLE CONTROLS

The ability to detect the ends of aisles and overcome any structural limitations relating to the construction and technical equipment of the building are crucial when it comes to improving safety.

In accordance with DIN 15185, Part 2, the truck must be braked to 2.5 km/h before the end of the aisle, without the intervention of the operators. The same rule applies to intersecting aisles in the warehouse, with the exception of escape routes. Jungheinrich end of aisle control systems are based on tried-and-tested RFID technology and transponders.

End of aisle control devices cause the truck to brake before exiting the aisle or on reaching a dead end. There are two basic variants:

1. Braking to a stop
2. Braking to 2.5 km/h

Note:

For both variants, the braking distance depends on the travel speed.

LIFT, LOWER AND TRAVEL CUT-OUTS

The lift and travel cut-outs are additional functions to support the operator when carrying out operations in warehouses with limited height, ceiling beams or beams.

They do not release operators from their personal responsibility:

- ▶ To terminate hydraulic operation, for example when approaching an obstacle
- ▶ To monitor and, if necessary, initiate the braking function, for example when monitoring the end of the aisle, braking on approach to an obstacle, etc.

Lift cut-outs are often combined with travel cut-outs. You can purchase multiple cut-outs in one cost-effective package. Your truck is then prepared for any changes in the warehouse at all times.

All switching functions can be assigned to individual aisles or storage areas and can also be reconfigured quickly and easily. Cut-outs can be activated via transponder (especially for narrow aisles) and wirelessly via zoneCONTROL (especially for larger storage areas).

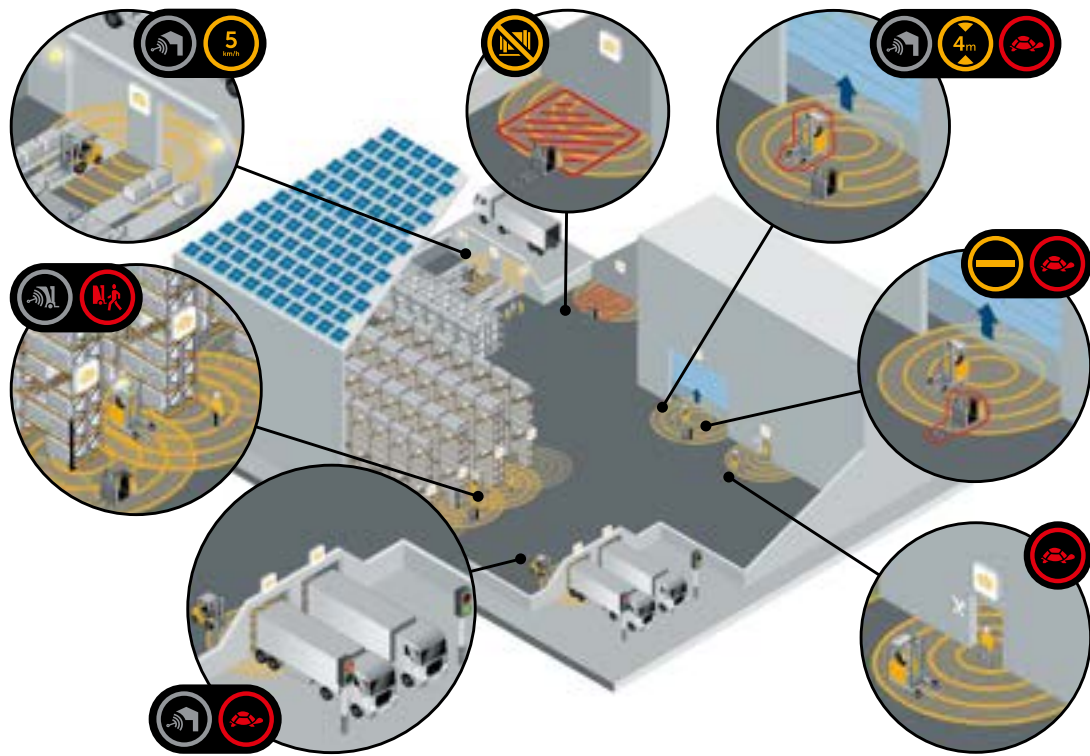

zoneCONTROL

As a radio-based application with a wide range of functions, the modular and flexible zoneCONTROL assistance system ensures maximum safety and efficiency in the warehouse. Targeted use of the system enables effective management of potential danger zones posing a high accident risk, such as low passageways, transition areas between buildings or crossings with poor visibility. Not only does this provide maximum protection in narrow aisles, but also across the entire warehouse environment.

As well as warning operators via the display or by means of an acoustic signal, the system also switches to slow travel to avoid collisions when an increased accident risk exists. In addition, traffic lights and warning lights can be connected to the radio anchor to warn the surrounding area in the event of danger.

The expandable assistance system is manufacturer-independent and very easy to configure, while the modular design enables situation-based adaptation to a wide range of applications.

All benefits at a glance:

- ▶ Situation-specific mitigation of risks in the warehouse
- ▶ Quick and simple display-based configuration
- ▶ No IT infrastructure required
- ▶ Easy to retrofit
- ▶ Modular design enables combination with other assistance systems



addedVIEW 360° CAMERA SYSTEM

addedVIEW is an all-round visibility system made up of digital cameras. Digital camera technology is especially good at responding to difficult lighting conditions by dynamically adjusting the exposure parameters. Excessively overexposed or underexposed image reproduction, for example in light-dark transitions between the different areas of the warehouse, is thereby avoided and operators always get a brilliant view of their surroundings. In addition, the use of digital cameras allows the image streams from the four individual cameras to be combined into one

real-time image and converted in such a way that operators can see their truck from a bird's-eye view. Most importantly, the truck profile is accurately incorporated into the seamless image. Thanks to addedVIEW, operators can navigate safely and quickly even in tight, congested situations with this all-round view. addedVIEW is currently available for the EKS, ensuring that operators are always in control, especially when lifting larger loads or picking frames.

Safety systems.

LEGAL BASIS

It is not permitted for people and industrial trucks to be in a narrow aisle at the same time ("time-delayed rack operation").

When operating a truck in narrow aisles, the operator must concentrate on the storage and removal process. Since the industrial truck is not more than 0.50 m away from the rack, people are at risk if they enter the narrow aisle at the same time as the industrial truck.

The risk of non-compliance must be completely eliminated: when operating trucks in narrow aisles, personal protection must be guaranteed despite the safety distance not being maintained.

In accordance with DIN 15185, Part 2, the following additional measures are required to meet this objective:

- ▶ **Structural measures.**
For example, walls, fences, doors, protection for passages in double-racks, safety markings using traffic signs.
- ▶ **Organisational measures** (in addition to structural / technical measures).
For example, operator's manual and training of warehouse staff, traffic management, written assignments for truck operators.
- ▶ **Technical measures at the entrances to the narrow aisles.**
For example, stationary, contactless personal protection system – protection of the entrances to the aisle with light barriers.
- ▶ **Technical installations on the industrial truck.**
Laser scanner on the stacker truck. Different solutions are used depending on the application.

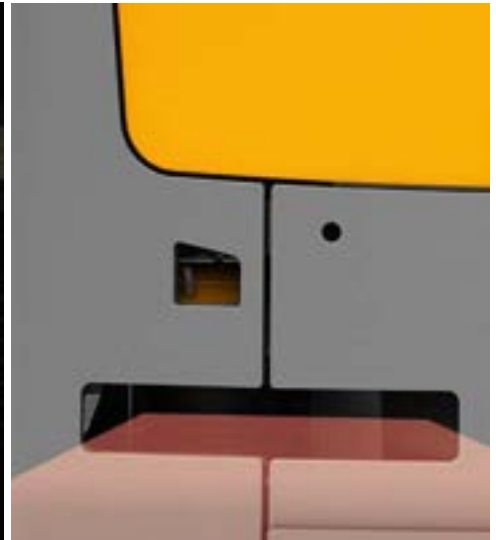

Functionality of one-way light barriers.

STATIONARY, CONTACTLESS PERSONAL PROTECTION SYSTEM

The stationary systems are used to secure the entrances to the aisles or entire access areas with light barriers.

One-way light barriers are used to detect people. The system monitors two heights: 400 mm and 900 mm. Two one-way light barriers (active column) or a single one-way light barrier and double mirroring (passive column) are used for monitoring purposes. A visual detection system clearly and reliably identifies the trucks, and also records the travel direction. This ensures an accurate count of the trucks.

PPS personal protection system.

The personal protection system must be certified for the required safety category. If it is possible to exit the aisle to the side into the racking system, it may also be possible to accidentally step onto the traffic route in front of an industrial truck.

Mobile personal protection systems or mobile personal protection equipment on industrial trucks have proven successful safety measures. These systems are contactless (e.g. using a laser scanner) and detect people or obstacles in narrow aisles. By identifying a hazard in good time, appropriate measures (e.g. stopping the truck) can be implemented and accidents prevented.

The system comprises two laser scanners: one fitted in the load direction and one in the drive direction. The PPS is then integrated into the architecture of the truck backup computer. A secure connection to the CAN bus is maintained. Control and analysis are performed by the truck central electronics system. The aforementioned transponder technology determines the precise distance and position of the truck. Each time the truck is put into operation, a self-test is automatically performed.

Jungheinrich supplies the truck including PPS with a "full certificate". This ensures that the truck and the PPS are CE compliant. The advantage of this is that you only have one contact for the entire system and only one accident prevention check for the truck and PPS.

FUNCTION:

- ▶ Automatic activation of protective and warning fields when entering the aisle for obstacle detection
- ▶ Visual and audible signal in the event of protective field and warning field breaches (visual indication on the display; audible signal: configurable volume and audio frequency)
- ▶ Length of protective and warning fields set according to the individual truck requirements
- ▶ Automatic deactivation of the PPS when the truck exits the aisle
- ▶ Reduced travel speed in load direction if the scanner is covered
- ▶ Prevention of unauthorised lowering of the cockpit seat into the scanning area. Three configurable override methods after PPS activation:
 1. Continued travel without restriction at crawl speed with override button
 2. Time-restricted continued travel at crawl speed – maximum 5 seconds
 3. Distance-restricted continued travel at crawl speed – maximum 1 pallet size



PPS Anti Collision.

Jungheinrich is able to expand the PPS personal protection system according to your individual needs. The following is provided for all modules: project planning, configuration, delivery, commissioning and maintenance from a single source, i.e. one contact person for the complete package: truck with PPS.

PPS STANDARD

Integrated personal protection system with obstacle detection using laser scanner technology. Automatic speed reduction or braking before obstacles.

PPS PLUS

Offers the same functions as PPS Standard but can also be configured with multiple warning and protective fields.

PPS ANTI COLLISION

In addition to PPS Plus, the extended PPS Anti Collision personal protection system provides reliable support when several trucks are operating in one aisle. The 15-metre wide anti-collision field not only improves safety in the warehouse, but also increases flexibility and throughput performance.

To prevent collisions, all trucks in the aisle must be equipped with PPS Anti Collision.

Process optimisation.

The digital transformation in the warehouse.

For a long time, the focus of intralogistics was on the further development of industrial trucks. The truck-specific performance parameters such as speed, load capacity, etc. have been continuously optimised. In the age of digitisation and Industry 4.0, software components are now becoming more and more important. Significant improvements in performance will be achieved in the future through intelligent networking of all components. As a system provider, Jungheinrich recognised this trend very early on and developed innovative solutions.

warehouseNAVIGATIO



WAREHOUSE MANAGEMENT SYSTEM (WMS)

Jungheinrich offers modular software solutions that you can use to optimise your warehouse, create faster, more efficient processes and minimise your return rate.



JUNGHEINRICH WAREHOUSE NAVIGATION

Based on RFID radio data transmission, our navigation solution steers your trucks safely and efficiently through the warehouse – even in highly frequented areas.



JUNGHEINRICH LOGISTICS INTERFACE

We offer an award-winning interface solution that allows you to network and control all devices in your warehouse. Even third-party devices can be integrated.

Mobile IT & scanning solutions.

Industrial IT and mobile data capturing ensure that communication in the warehouse is networked and therefore efficient. All of your employees receive their stacking, removal and picking orders directly from the WMS, either displayed on their truck terminal or hand-held terminal or announced through headphones via Pick-by-Voice systems. There is no longer a need for the complex handling of paper lists. Barcode scanning enables all goods movements to be checked immediately by the WMS. All the information about the inventory is up to date at any given moment, as all goods movements are radioed to the WMS. Our trucks offer a variety of interfaces and installation positions for the ergonomic integration of a wide range of industrial WMS end devices, from truck terminals or hand-held terminals to tablets and printers through to automatic or manual barcode scanners.

Advantages:

- ▶ Up-to-date data in ERP (Enterprise Resource Planning) and/or WMS at all times
- ▶ Quick, paperless order processing
- ▶ Satisfied customers and lower costs for returns handling due to a reduction in errors
- ▶ Can be used in different environments, e.g. deep-freeze stores

SCOPE OF DELIVERY.

- ▶ Consulting
- ▶ End device installation, commissioning and training
- ▶ Wi-Fi simulation, configuration and analysis
- ▶ Maintenance and service



Jungheinrich WMT truck terminal.



Automatic scan carried out by fork carrier.

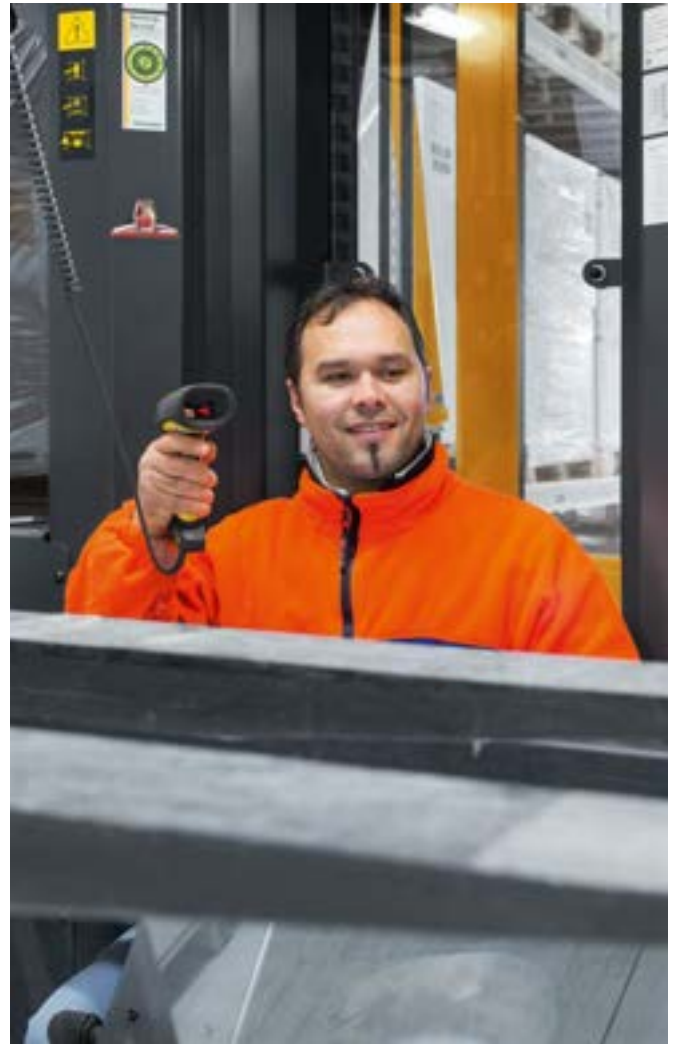

Manual barcode scanner.

OPTIMUM RADIO COVERAGE IN EVERY WAREHOUSE

A functional wireless network forms the basis for real-time communication with the trucks and mobile devices. Our experienced consultants would be happy to help you choose a suitable solution and integrate our devices into your existing infrastructures.

We can provide consultations, planning, configuration and analysis for your Wi-Fi from a single source.

Thanks to our high-availability and high-performance Wi-Fi infrastructure, your employees can access the Warehouse Management System or ERP system data directly in the warehouse – and move freely in all areas covered by Wi-Fi.

To plan the required number and position of wireless access points, we create a simulation based on the layout of your warehouse that even takes into account the attenuation of Wi-Fi signal due to warehouse structures. Even in complex logistics and production areas, we can help you set up a functional Wi-Fi infrastructure.

During installation, we rely on high-quality, industry-standard Wi-Fi components, which we can configure according to your requirements. Alternatively, we can carry out a system and performance analysis to document and optimise an existing environment.

Logistics Interface.

The Logistics Interface is a versatile communication interface that links machines and processes within the warehouse to form intelligent systems. It enables simple and efficient communication between Jungheinrich trucks, warehouse equipment and the warehouse management software, e.g. the Jungheinrich Warehouse Management System (WMS) or alternatively a higher-level host system. Even in small warehouses without a WMS, the Logistics Interface delivers optimised truck control and more efficient warehouse processes – including a paperless goods receipt process, autonomous item management for lift and carousel systems and our intelligent assistance systems. The Logistics Interface brings Industry 4.0 and the Internet of Things (IoT) directly to your warehouse.

The Logistics Interface is a versatile communication interface that links machines and processes within the warehouse to form intelligent systems.



RFID technology.

TRANSPONDER TECHNOLOGY:

- ▶ Provides information for the management of narrow aisle trucks
- ▶ Ground control and communication with the storage environment
- ▶ Various programming and speed profiles

TRANSPONDERS AS INFORMATION CARRIERS

Being able to control narrow aisle trucks in aisles and warehouse zones is critical for safe operation and maintenance of all prescribed functions, such as end of aisle control, lift cut-outs and travel speed reductions.

Transponders are used to control our narrow aisle trucks. They measure just 9 x 16 mm and are set into the warehouse floor at intervals of no more than 10 m. The truck itself is equipped with an RFID reader/writer that communicates with the transponders, and selects and uses the following information:

- ▶ Identification of the aisle number and aisle type
- ▶ Referencing of the route measurement within the aisles

Based on the above information and the existing route measurements of the truck, the system allows locations to be determined precisely within the aisles at all times. The reader programs the transponders. The warehouse topology is stored in the memory of the truck on-board

computer. This means that switching functions can be activated at any point, such as speed reductions for crossing escape routes or lift cut-outs in aisles with limited overhead clearances.

HIGH FLEXIBILITY – LOW MAINTENANCE

High flexibility and responsiveness to future changes in the warehouse structure are the main advantages of transponder technology. If a racking row changes, or shelves are added, the transponders are simply reprogrammed and the changed structure is saved in the truck computer. Cut-outs can be configured using a laptop and adapted to new situations. This is a key advantage, especially for logistics service providers.

As the transponders are protected in the ground, the technology is not sensitive to damage or contamination.

RELIABILITY

Jungheinrich transponder technology meets high standards in terms of reliability and security in data processing. The entire computer system of the narrow aisle truck is redundant, i.e. designed with two channels, with a master computer and backup computer.

Data communication within the onboard computer and communication to the motors and sensors takes place via a secure CAN bus certified by the technical inspection authority.



A pioneer since 2007: transponder technology.



GPS in the warehouse – precise positioning in every situation.

OPTIMISATION OF PERFORMANCE ACCORDING TO FLOOR TOPOLOGY

The transponder technology not only offers advantages in terms of safety, but also enables the travel speed profiles to be optimised according to the floor topology. In practical applications, the evenness of the ground often determines the maximum travel speed ($V_{max.}$) of the truck. In many cases, the floor quality is not consistent and the travel speed often has to be reduced due to a small number of poor-quality areas. With the new system, it is now possible to adapt the speed profiles to the respective situation and only drive slowly where the floor requires it. Pallet throughput is increased as a result.

RELOCATION OF THE TRANSPONDERS

The transponders are lowered to a depth of approx. 2 mm in the drilled transponder hole (drilling depth 20 mm) with the help of silicone (vinegar-free) and inserted. The distances between the transponders and the centre of the aisle are 245 mm.

EXAMPLE OF TRANSPONDER INSTALLATION IN A "DEAD END"

RG range 1,670 mm: $2 = 835 - 245 = 590$ mm

A template can then be created and used as an assembly aid.

Three transponders must be placed at the start of the aisle:

1. At a distance of 0 mm – start of the aisle (height of the first rack column)
2. Distance of 500 mm – to monitor the start of the aisle
3. Distance of 5,000 mm – monitoring function

All other transponders are laid at a distance of ~ 10,000 mm to monitor the route.

warehouseNAVIGATION.

INCREASED EFFICIENCY BY INTEGRATING THE TRUCKS INTO THE PROCESSES

RFID technology enables businesses to achieve their objectives.

GENERAL INFORMATION

As described in the "Flooring – Structure and requirements" section, the performance data of high-rack stackers has improved rapidly in recent years due to 3-phase AC technology.

The lift speed is currently over 0.5 m/s and travel speed is 12 km/h. This represents almost a doubling of the values achieved over the past 20 years.

It is highly unlikely that these levels of improvement will be repeated, since the physically acceptable limit has more or less been reached. The forklift trucks of the future will not only have to be powerful performers, they will also need to have intelligent technology on board to interface with the IT and integrate them into logistical processes.

Initially, transponder technology was used for truck management, i.e. ground control and communication with the rest of the warehouse; it therefore governed all the switching functions and speed profiles.

In the second stage of development, transponder technology offers optimum preconditions for warehouseNAVIGATION. warehouseNAVIGATION is based on ongoing monitoring of the truck location and the interfacing of the truck controller with a higher-level control system.

This system takes the load off the operator, increases throughput and helps avoid order-picking and stacking errors.

SYSTEM DESCRIPTION

warehouseNAVIGATION utilises the features of transponder technology for navigation and the approaching of pallet locations with pinpoint accuracy. All transport or picking orders are transmitted from the Warehouse Management System (WMS) by radio data to the truck terminal. From there, the X, Y and Z coordinates of the location are transferred directly to the truck controller via a serial RS232 interface. This enables the truck to identify the respective target location and approach it semi-automatically. The operator sees the travel and lift directions on the display and, when the functions are confirmed, the truck automatically approaches the position with pinpoint precision, with diagonal travel for optimum timing.

1

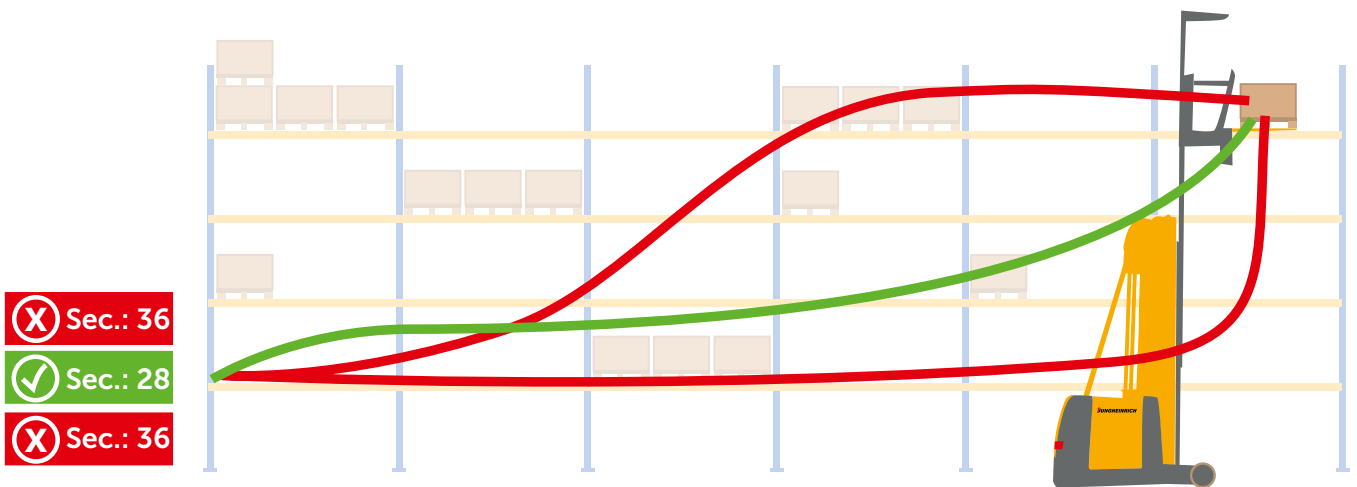

When the forklift truck has been positioned, a picking spotlight (option) illuminates the picking position and shows the operator the side and box from which the order should be picked. The truck operator no longer needs to concentrate on things like:

- ▶ Approach routes
- ▶ Searching for pallets
- ▶ "Ideal times" for initiating diagonal travel
- ▶ Scanning barcodes as confirmation for the WMS in the case of combi-stackers

warehouseNAVIGATION takes care of all these functions for the operator. Unnecessary journeys and adjustments are therefore eliminated.

warehouseNAVIGATION:

- ▶ In the shortest time
- ▶ Over the shortest distance
- ▶ With as much energy as needed yet as little energy as possible

You can find a template to calculate economic efficiency in the "Process optimisation – Energy efficiency in the warehouse" section. The system consultant can also carry out an individual calculation tailored to your requirements.

THE ADVANTAGES OF WAREHOUSENAVIGATION:

1. A comparison – EKX with/without warehouseNAVIGATION.

Optimised approach with warehouse navigation allows time savings of up to 25%. The "green curve" proves this: in the shortest time and over the shortest distance, with as much energy as needed yet as little energy as possible.

2. Intelligent target approach of an EKX with warehouse navigation.

The truck computer calculates the quickest way to the target position. When the travel lever is actuated, all sequences required for positioning are optimised, for example travel distance and speed based on the route, start of lift based on the route and start of lift based on the target height.

3. Dynamic storage area management.

No matter how the pallets are stored, warehouseNAVIGATION masters the layout and always heads for the right location. The Warehouse Management System controls the process.

2

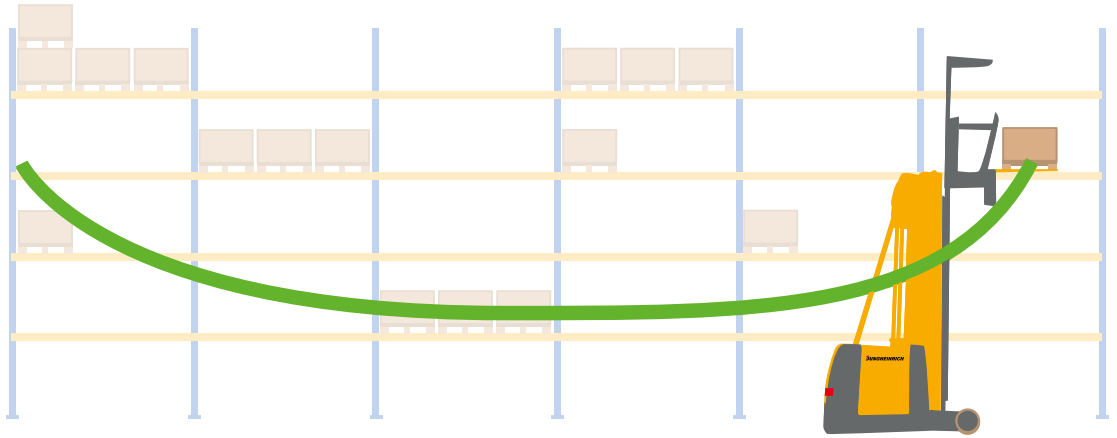

3

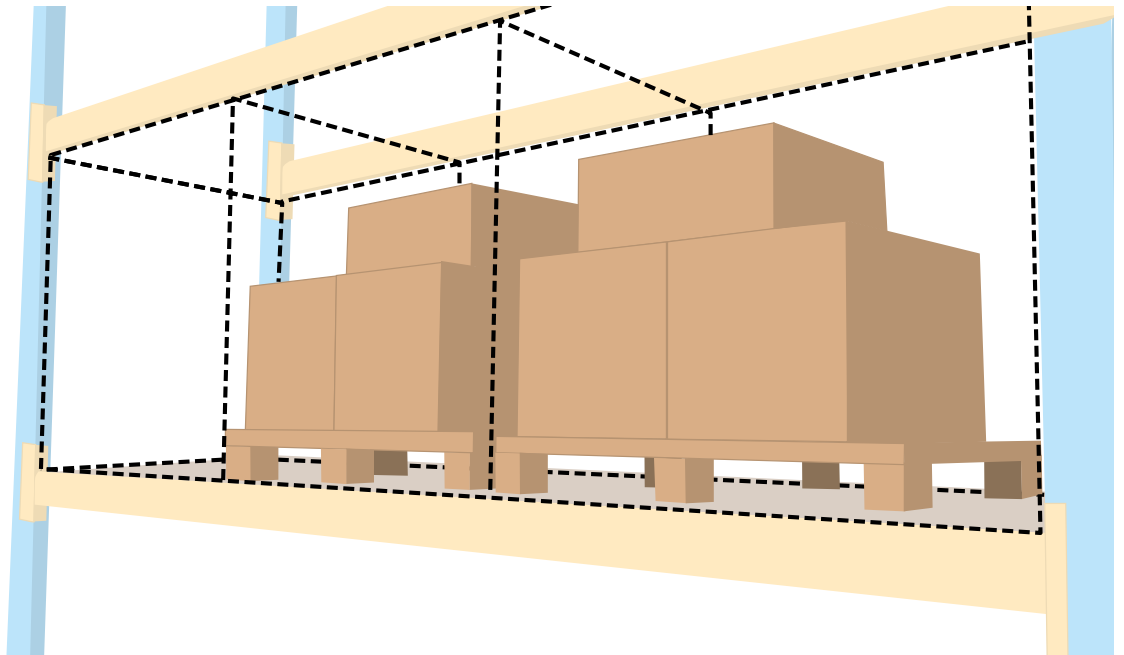

Jungheinrich WMS.

Bring Jungheinrich quality to your processes.

Controlling small and medium-sized warehouses efficiently is possible with Jungheinrich WMS Essential. Tried-and-tested and standardised processes make it easier for you to enter the future of digital warehouse management. Not only can you monitor your inventory and orders at all times, but you can also organise all processes in your warehouse more economically and transparently than ever before, from goods receipt to stacking and removal as well as order picking and goods issue.

Jungheinrich WMS Essential can be implemented quickly thanks to its modular structure; it is seamlessly integrated into your existing IT system landscape and is designed to be forward compatible. This means that it can be adapted to your new requirements at any time and expanded accordingly. Flexibility is also the maxim when it comes to price: you may choose between a one-off payment or software-as-a-service licensing.

- ▶ Efficient control of small and medium-sized manual warehouses
- ▶ Support for the most common warehouse technologies
- ▶ Practical functions such as label printing and warehouse zoning
- ▶ Intuitive operation thanks to modern, user-friendly interface
- ▶ Flexible expandability due to modular design
- ▶ Attractive entry price
- ▶ Fast implementation thanks to standardised processes
- ▶ Easy integration thanks to interfaces to all common host systems
- ▶ Trained support with up to 24/7 availability
- ▶ Upgrade to the even more extensive Jungheinrich WMS possible at any time

The integrated control panel with dashboard enables you to utilise and control your personnel and material resources at any time. You also have the option to process your orders in a timely manner and with significantly less effort.



The GS1 module can be used to scan and print labels in Global Standard One format. The Serial number management and Batch management modules make it significantly easier to identify the goods.



The Dock & yard management module enables you to model and fully manage ramps and parking areas – seamlessly integrated into all your warehouse processes in the Jungheinrich WMS.

Trucks in the narrow-aisle warehouse.

Steer your warehouse to success.

Jungheinrich trucks introduce a new dynamic to your warehouse processes. We offer the right truck for every storage strategy, every area of application, every storage height. Choose the solution that best meets your needs from a variety of truck types and variants. Operators can enjoy high efficiency, optimum comfort and ergonomics, and maximum safety during operation at all times. Sophisticated technology, energy-efficient drive concepts and a wealth of options can prepare your truck for any application scenario. We also offer the perfect solution for step-by-step automation of your warehouse environment.

Contact us and we will be happy to help! We can provide standard trucks that have been tried and tested many times or configure everything individually on request.





The truck is based on the man-down principle, whereby the fork goes up and the travel platform remains on the ground.

The modular truck concept with front seat and laterally positioned mast allows unrestricted visibility of the fork, load and route.



SERIES	CAPACITY / LOAD	LIFT HEIGHT (MAX.)	TRAVEL SPEED (MAX.)	LIFT SPEED (MAX.)
EFX 411	1,100 kg	7,000 mm	9 km/h	0.45 m/s
EFX 414	1,360 kg	9,000 mm	9 km/h	0.45 m/s

EFX 410 / 413: All-rounders with a front seat.

Well-suited to every application scenario.

OPTIMUM VISIBILITY DURING STORAGE AND REMOVAL PROCESSES

The versatile series 4 electric tri-lateral stackers are suitable for combined use in narrow aisles, wide aisles and in the loading area. The modular truck concept with front seat and side-mounted mast ensures an excellent view of the fork, load and route. The working principle is based on the "man down" approach, with the fork moving up while the travel platform remains at floor level. The 48-V 3-phase AC technology can achieve high goods throughput with low energy consumption. The large display, height-adjustable control panel and spacious storage provide a comfortable working environment.

- ▶ Unique truck concept with front seat and side-mounted mast
- ▶ Unrestricted visibility during travel, storage and removal processes
- ▶ High level of customisation with service packages and assistance systems
- ▶ Effective energy management: regenerative braking and regenerative lowering
- ▶ Optional: personal protection system for optimised safety



Integrated, handy steering wheel for precise and safe handling.



Connection to the Warehouse Management System (WMS) can improve throughput by up to 25%.

EKX 410–516: The top performers in the segment.

Productivity at its best.

THE UNDISPUTED LEADER IN THE NARROW-AISLE WAREHOUSE

The powerful and efficient EKX series 4 and 5 tri-lateral stackers are suitable for stacking and removing entire pallets or picking individual items in high-bay racks. Ideal for both medium lift heights and lift heights of up to 18 metres, our EKX can take your warehouse logistics to a whole new level. The travel platform and fork are always at the same height (man-up principle). Do you prefer to work sitting down or standing up? Now, operators can decide for themselves thanks to the spacious travel platform. The patented vibration damping, RFID ground control and smart assistance systems guarantee optimal handling and maximum safety.

- ▶ Maintenance-free and highly efficient synchronous reluctance motors
- ▶ Intelligent truck positioning using RFID technology
- ▶ Vibration dampening for use on uneven floors (optional)
- ▶ Modular system with 5 million configuration options (step-by-step automation possible)
- ▶ Electrical control panel adjustment (optional)



An ergonomic workplace perfectly tailored to the needs of the operators.



Greater safety and travel comfort on uneven floors with Floor Pro.

SERIES	CAPACITY / LOAD	LIFT HEIGHT (MAX.)	ORDER PICKING HEIGHT (MAX.)	TRAVEL SPEED (MAX.)	LIFT SPEED (MAX.)
EKX 410	1,000 kg	11,500 mm	10,530 mm	10.5 km/h	0.4 m/s
EKX 412	1,200 kg	11,500 mm	10,530 mm	10.5 km/h	0.4 m/s
EKX 514	1,400 kg	13,000 mm	11,530 mm	10.5 km/h	0.45 m/s
EKX 516k	1,600 kg	14,000 mm	12,530 mm	12 km/h	0.6 m/s
EKX 516	1,600 kg	18,000 mm	16,530 mm	12 km/h	0.6 m/s



An intelligent configuration of personal protection scanners on the EKXa provides 360° safety. This enables the EKXa to be used in an automated narrow-aisle warehouse without the need for perimeter fencing and Area Access Control.



The trucks communicate with higher-level management and control systems via Wi-Fi.

MODEL	CAPACITY	MAXIMUM LIFT (H3)	TRAVEL SPEED	BATTERY VOLTAGE
EKX 514a	1,400 kg	11,000 mm	10.5 km/h	80 V
EKX 516ka	1,600 kg	12,000 mm	12 km/h	80 V
EKX 516a	1,600 kg	13,000 mm	12 km/h	80 V

EKX 514a / 516ka / 516a: Mobile robots.

Automation improves performance in narrow aisles.

FAMILIAR PLATFORM – UNPRECEDENTED LEVEL

Our powerful and modular EKXa trucks are impressive mobile robots, developed on the basis of our proven EKX electric high level combination order picker/three-lateral stacker. The EKXa is characterised by maximum performance at lift heights of up to 13,000 mm and is setting new standards within automated narrow-aisle warehouses.

Equipped with an 80-V drive and a maintenance-free synchronous reluctance motor, it achieves completely new performance dimensions while simultaneously reducing energy consumption. The optional integration of an on-board charger plus conductor rail and current collector makes it optimally equipped for 24/7 use. The optional 360° safety sensor system enables use of the EKXa in an open, unfenced narrow-aisle warehouse. With the pallet and clearance detection option, it is possible to automate existing racking within previously manually operated narrow-aisle warehouses.

- ▶ Can be automated in phases.
- ▶ 360° safety sensor system for use in open narrow-aisle warehouses.
- ▶ Pallet and clearance detection for use with existing racking in manual narrow-aisle warehouses.
- ▶ Optional on-board charger for 24/7 operation.
- ▶ Planning, implementation and After Sales Service from a single source.



As experts in automation, we will be on hand at every stage from the initial consultation to ongoing operation, and beyond.



Optional equipment with onboard charger, busbar and current collector for efficient 24/7 use.

EKS 3s and EKS 4s: The performance enhancers in narrow aisles.

Providing outstanding performance in multi-shift operation.

EKS 310s

This narrow-aisle order picker completes all tasks with maximum speed and precision – even in the tightest spaces. In addition to the 48 V control concept, the truck features a newly developed synchronous reluctance motor that maximises efficiency while keeping energy losses to an absolute minimum.

- ▶ Optional safety and personal protection systems for greater safety, even during peak operation
- ▶ Intelligent system connection via the Logistics Interface ensures significantly faster processes

EKS 412s

The flagship in our range of narrow-aisle order pickers sets new standards with maximum picking performance up to heights of 14 metres. No other order picker worldwide can match this figure. Lithium-ion power allows you to exploit the full potential of the new motor generation, while our lead-acid batteries guarantee two shifts with just a single charge. Seamless integration in your warehouse system ensures that both s models deliver maximum efficiency.

- ▶ Up to 25% increase in throughput performance thanks to warehouseNAVIGATION
- ▶ capacityPLUS (optional) for increased residual capacity



When speed is of the essence: with outstanding travel and lift acceleration, you can complete more picks every hour.



Greater comfort and individuality thanks to wide entry, height-adjustable control panels and a clearly arranged 4-inch display.



Simply depress the accelerator and the warehouseNAVIGATION system guides the operator to the destination via the shortest route.



Maximum narrow-aisle performance in multi-shift operation with the EKS.



Maximum availability of all trucks – thanks to rapid booster charging and recharging.

SERIES	APPLICA-TION	CAPACITY / LOAD	ORDER-PICKING HEIGHT (MAX.)	TRAVEL SPEED (MAX.)	LIFT / LOWERING SPEED (MAX.)
EKS 110	Wide aisle + narrow aisle	1,000 kg	4,600 mm	12 km/h	0.25 m/s
EKS 210	Wide aisle	1,000 kg	6,600 mm	10 km/h	0.3 m/s
EKS 310	Wide aisle	1,000 kg	8,845 mm	10 km/h	0.3 m/s
EKS 412	Wide aisle	1,200 kg	10,845 mm	10 km/h	0.3 m/s
EKS 310s	Narrow aisle + wide aisle	1,000 kg	8,845 mm	12 km/h	0.5 m/s
EKS 412s	Narrow aisle + wide aisle	1,200 kg	14,345 mm	12 km/h	0.5 m/s

Energy supply.

Sustainability meets performance.

The energy supply in the warehouse is critical to achieving the desired productivity. Depending on the intensity of use (single-shift operation, multi-shift operation, continuous use), different concepts are available that ensure fail-safe, economical operation. As well as producing a wide variety of solutions, the advantage of using Jungheinrich is that we offer a complete system of fully compatible components, from trucks and batteries to coordinated charging solutions. By carrying out a preliminary energy consultation, we can determine which solution is best suited to you and your individual performance goals.

Jungheinrich demonstrates innovative strength particularly in the field of lithium-ion technology. As the world's leading supplier of lithium-ion batteries for warehouse applications, we have already helped many customers to improve their performance, save energy and reduce CO₂ emissions. Find out more about pioneering energy systems and the impressive Jungheinrich guarantees in this sector.



Energy solutions at a glance.

A battery and charger can be combined to create a powerful system with a long service life and economical costs. This requires careful planning taking into consideration the application to determine whether discharged batteries should be recharged inside or outside the truck.

Your Jungheinrich consultants and energy experts will be happy to help you select and implement the right energy solution for your application.

	ONE-SHIFT OPERATION		MULTI-SHIFT OPERATION		CONTINUOUS OPERATION
Battery technology	Lead-acid	Li-ion	Li-ion	Lead-acid	Lead-acid
Charging technology	The truck is typically charged using a battery charger, which is connected to the truck. Special conditions are required for the charging area (see VdS 2259).	The truck is typically charged using a battery charger, which is connected to the truck using an easy-to-reach comfort charging socket. Thanks to the lithium-ion technology, multiple shifts can be completed with booster charging during breaks.		The discharged battery is removed from the truck and a charged replacement battery is inserted. The truck can be put back into operation immediately. In the case of narrow-aisle trucks, the battery is replaced from the side.	The lead-acid battery is charged using an onboard charger and a busbar attached to the rack. Charging is ongoing and the truck can be used continuously.

Simple charging of
Li-ion trucks.



Simple charging using the
comfort charging socket.



Charging lead-acid batteries
in a separate battery area.

90

ENERGY SUPPLY
LI-ION TECHNOLOGY



Three times longer
service life than with
lead-acid batteries.

0.0

Zero
maintenance.



Up to 8 years
on the
warranty.



Significantly higher
endurance in multi-
shift operation.



Charged up to 50%
with a booster
charging time of just
30 minutes.

Li-ion technology.

Thanks to our own research, development and production, we can offer you a lithium-ion concept that is unique on the market. A complete, networked system in which the lithium-ion battery or rechargeable battery, charger and truck are perfectly harmonised. The technology is supported with expert advice at all times. This results in high power and performance, fast charging times, intelligent energy recovery, elimination of maintenance to save time and resources, and a service life that is three times longer.

Lithium-ion technology offers the following advantages:

- ▶ Reliably high performance even when the battery is no longer fully charged, since the voltage curve in lithium-ion batteries is more constant than in lead-acid batteries
- ▶ Rapid charging and booster charging during breaks or downtimes for 24/7 truck availability and flexibility in everyday warehouse operations
- ▶ With a booster charging time of just 30 minutes, the battery absorbs up to 50% of its capacity (depending on the combination of battery and charger)
- ▶ No need to top up with water
- ▶ No need for special charging areas with ventilation. No dangers or unpleasant odours due to gases or acids
- ▶ No battery exchange systems with heavy drains on time and human resources
- ▶ Jungheinrich often uses lithium iron phosphate (LiFePO), currently the safest cell chemistry, which is non-toxic and non-hazardous from an ecological perspective
- ▶ Transport and disposal of the lithium-ion batteries is performed by our trained Service team

Energy efficiency.

The narrow-aisle warehouse already actively contributes to the sustainable use of resources due to its small footprint. As well as occupying less space, there is a smaller area to light and heat; however, the storage capacity is still sufficient.

The Jungheinrich narrow-aisle trucks further contribute to improved energy efficiency in a variety of ways.

INCREASED PERFORMANCE WITH REDUCED ENERGY CONSUMPTION

Our new, maintenance-free synchronous reluctance motors are the most efficient in their class. They reduce energy loss while simultaneously increasing performance with a lift speed of up to 0.6 m/s, a reach speed of up to 0.5 m/s and a travel speed of up to 12 km/h. This allows you to perform more work cycles in a shorter time. Our EKK and EKS models both incorporate this motor technology.

The Jungheinrich narrow-aisle trucks not only save energy, their patented valve technology also allows them to recover energy both when braking and when lowering. The advantages include optimised energy management and less wear and tear on the components.

The intelligent lightweight construction and high-tensile steels also contribute to outstanding energy efficiency.

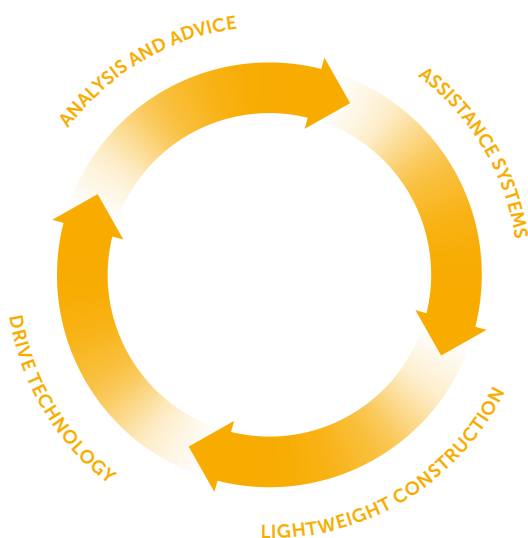

Jungheinrich relies on a holistic energy concept. We analyse your process and offer ongoing advice in order to keep optimising the energy requirement. Our trucks make an important contribution to reducing energy costs thanks to their lightweight construction. Assistance systems also have an immediate positive effect on the energy footprint, for example when the navigation system opts for the shortest route.



**2SHIFTS
1CHARGE
GUARANTEED**

Efficiency means achieving more with less. And this is exactly what the new EKX does for you. Thanks to the state-of-the-art motor and energy-saving technology, consumption and wear and tear are significantly reduced. You save costs and at the same time extend your operating times.

By offering the best CO₂ footprint in its class, we guarantee that the truck can complete up to two shifts without replacing the battery.

Special solutions.

Individual system trucks for every application.

There are warehouse environments that present particular challenges, for example due to complicated spatial conditions, goods that are difficult to store or transport tasks that are fairly difficult to control. In these situations, individuality and creativity are required when finding a solution. Jungheinrich combines the experience of an industrial series manufacturer with the customer focus of a manual production facility. The modular design of our trucks has proven to be a great asset. A modular approach makes it possible to translate your special requirements into ready-to-use trucks that are optimally designed for their intended purpose, regardless of whether trucks are for individual production or series production.

**MODULAR SYSTEM**

Existing system trucks can be adapted precisely to your application in a time and cost-efficient manner with custom frame lengths and widths, individual load handling attachments, mast variants, tailor-made order-picking platforms and much more.

**CONTROL SYSTEM
CERTIFIED BY THE
TECHNICAL INSPECTION
AUTHORITY**

Certified safety guaranteed; also available for individual system trucks.

**CE-MARKED FOR SAFETY**

All modifications and options have been extensively tested in use with the truck.

**INDUSTRY EXPERIENCE**

We have already successfully developed custom-made products for various industries and environments, for example tyre manufacturers, furniture and textile industries, transport and logistics, pharmaceuticals and food.

EKK special cold store equipment.

The popular, award-winning high-rack stacker for use in lower temperatures.

THE NUMBER ONE FOR SPECIALIST APPLICATIONS IN NARROW AISLES

Even the standard EKK portfolio boasts a number of benefits, including an energy-saving drive concept, flexible application options and excellent ergonomics. The cold store version of the multiple award-winning model offers all this and more. You too can benefit from one of the most successful high-rack stackers in the food or pharmaceutical sector. The design is completely frost-proof. All central components are made of low-temperature steel, low-viscosity hydraulic oil is used and the windows are made of double polycarbonate. In the version with a heated, fully insulated cabin, the operators enjoy comfortable conditions at low ambient temperatures, while energy consumption remains low thanks to the maintenance-free synchronous reluctance motor. In the version without a driver's cabin, the truck is ideal for a combination of order picking and pallet handling. With 5 million configuration options, you are sure to find the right solution for every application.

Your benefits at a glance:

- ▶ Maximum flexibility and performance from -2°C to -28°C
- ▶ High-quality materials ensure the durability and operational readiness of the truck in low-temperature environments
- ▶ Maintenance-free synchronous reluctance motor for optimum energy and cost efficiency
- ▶ Comfortable conditions for the operators thanks to two-stage heating, a supply of fresh air and an adjustable electric control panel
- ▶ Suitable for different storage types and storage strategies



In the heated cabin, operators are safely protected from the cold ambient temperature.

Guidelines and standards.

GUIDELINES / STANDARD	DESCRIPTION	PAGE
DIN 18560, Part 7, Tab. 1	Floor screeds – Part 7: Heavy-duty screeds (industrial screeds)	10
DIN EN 1081	Resilient, laminate and modular multilayer floor coverings – Determination of the electrical resistance	10
DIN 1045	Concrete, reinforced and prestressed concrete structures	10
DIN 18202	Tolerances in building construction – Buildings	10
VDMA / FEM 4.103-1/ FEM 10.2.14-1	Floors for use with VNA Trucks	10
DIN EN ISO 3691-3	Industrial trucks – Safety requirements and verification – Part 3: Additional requirements for trucks with elevating operator position and trucks specifically designed to travel with elevated loads	40
DIN EN 15512	Steel static storage systems – Adjustable pallet racking systems – Principles for structural design	14-19
DIN EN 15620	Steel static storage systems – Tolerances, deformations and clearances	14-19
DIN EN 15629	Steel static storage systems – Specification of storage equipment	14-19
DIN EN 15635	Steel static storage systems – Application and maintenance of storage equipment	14-19
DIN EN 15095	Power-operated mobile racking and shelving, carousels and storage lifts	20-21
DIN EN 15629	Steel static storage systems – Specification of storage equipment	22-25
DIN EN 15635	Steel static storage systems – Application and maintenance of storage equipment	22-25
FEM 10.2.06	The Design of Hand Loaded Steel Static Shelving	22-25
Directive 2006/42/EC Directive 2014/30/EU	Machinery Directive Directive for electromagnetic compatibility (EMC Directive)	26-27
DIN EN ISO 13849-1	Safety of machinery – Safety-related parts of control systems – Part 1: General principles for design	54
DGUV Regulation 68	German accident prevention regulations for fork lift trucks	54
DIN 15185-2	Industrial trucks – Safety requirement – Part 2: Use in narrow aisles	57

A leader in intralogistics. There for you across the globe.

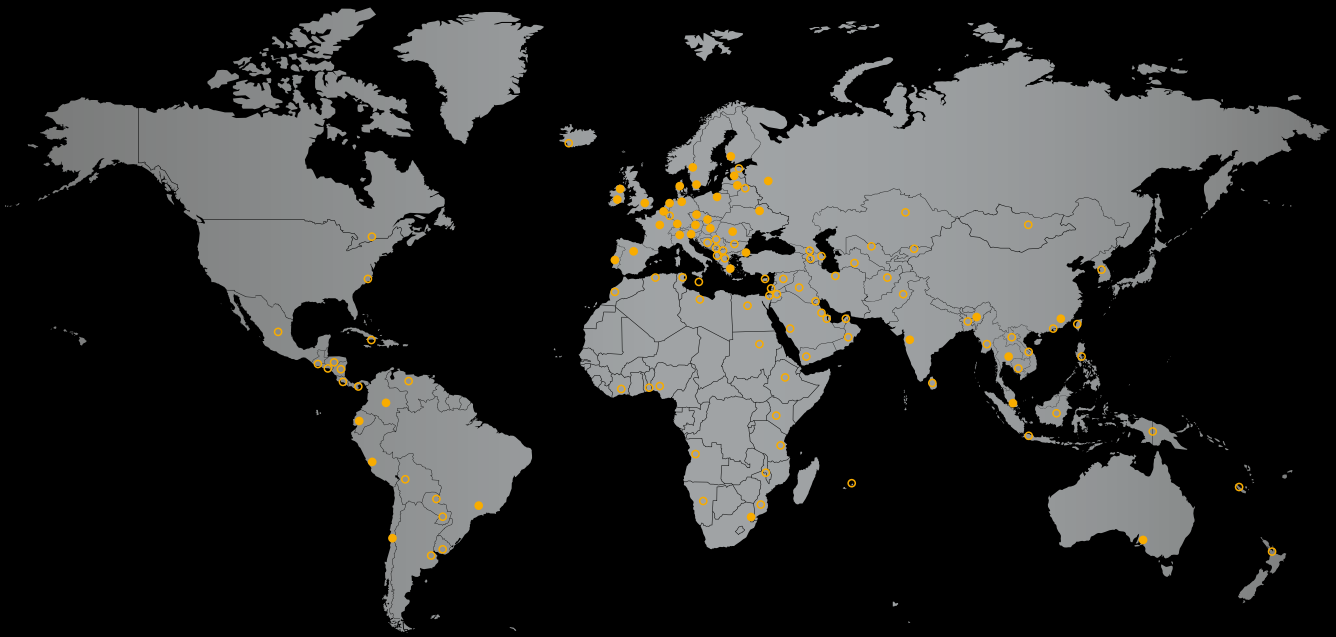

● Our own direct sales companies in 42 countries.

○ Partner companies in around 80 other countries

More than 20,000 employees.

More than 6,100 service engineers worldwide.

Founded in 1953, Jungheinrich is one of the world's leading providers of intralogistics solutions. With a comprehensive portfolio of industrial trucks and automated components, as well as services, we offer tailor-made solutions that allow you to devote your full attention to your core business. With our unique direct sales and service network, you can call upon a reliable partner who is at your side at all times, wherever you may be in the world.



AUTOMATED SYSTEMS

Based on our comprehensive process knowledge and extensive experience in a wide range of industries, we can provide you with tailor-made automated systems, ranging from semi to fully automated solutions. We will thus work together to raise your efficiency and productivity to a whole new level.



NEW TRUCKS

Lifting, stacking, transporting, order picking – electrically, by combustion engine or by hand? Our product portfolio contains the perfect trucks for your needs.



WAREHOUSE EQUIPMENT

From pallet racking to automated small parts warehouses, we have the right solution for every item and warehouses of all sizes. Combined with Jungheinrich industrial trucks and IT solutions, the result is a future-proof, integrated intralogistics concept of unique quality.



RENTAL

Forklift truck rental is not just an ideal solution for addressing short-term or seasonal requirements. Jungheinrich offers "power on demand" for all companies, regardless of their size or industry. There are rental solutions available to suit all requirements, with trucks available instantly in a wide number of variants across the globe.



USED TRUCKS

JUNGSTARS are used trucks from Jungheinrich, which are among the best on the market. With high-end reconditioning according to our 5-star principle, every truck is returned to an outstanding technical and visual condition to satisfy the highest safety and sustainability standards.



DIGITAL SOLUTIONS

With intelligent software and sophisticated hardware components, we ensure complete digital networking within your warehouse. All processes can be monitored centrally and controlled with utmost efficiency. Systems from different manufacturers can also be integrated with ease.



CONSULTING

Products and services must meet your exact requirements. That is why our consulting service combines a high level of technical ability with process knowledge and in-depth industry expertise. We can thus work together to identify the perfect complete solution.



FINANCING

Jungheinrich Financial Services is your reliable partner throughout the entire life cycle of your Jungheinrich product. We offer individual solutions for trucks, racking, warehousing and system solutions, while taking your budget and the special requirements of your business into account.



AFTER SALES

The trouble-free operation of your intralogistics solution is our top priority. That is why we offer reliable, global support for your trucks and systems with more than 6,100 qualified service engineers. This allows us to be on-site within a very short time frame to restore the availability of your trucks and systems.

ISO 9001 The German production facilities
ISO 14001 in Norderstedt, Moosburg, Landsberg
and Kaltenkirchen are certified.

 Jungheinrich trucks
conform to the European
Safety Requirements.

Jungheinrich Aktiengesellschaft

Friedrich-Ebert-Damm 129
22047 Hamburg
Germany
Telephone +49 40 6948-0
Telefax +49 40 6948-1777

info@jungheinrich.com
www.jungheinrich.com

 **JUNGHEINRICH**